

REV.	DESCRIPTION	DRAWN	CHECKED	APPROVED
A	NEW RELEASE	LJH 09/20/05'	~	LJC 09/20/05'
B	料号中增加尺寸DIM. H, E选项	YCH 07/18/08'	~	

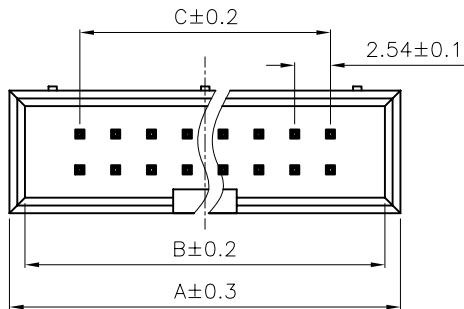
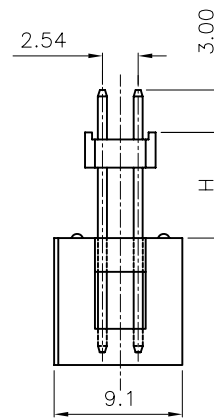
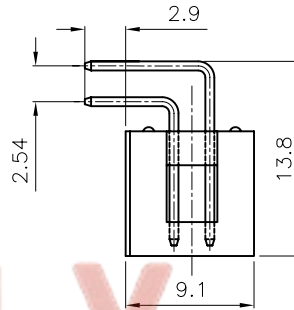
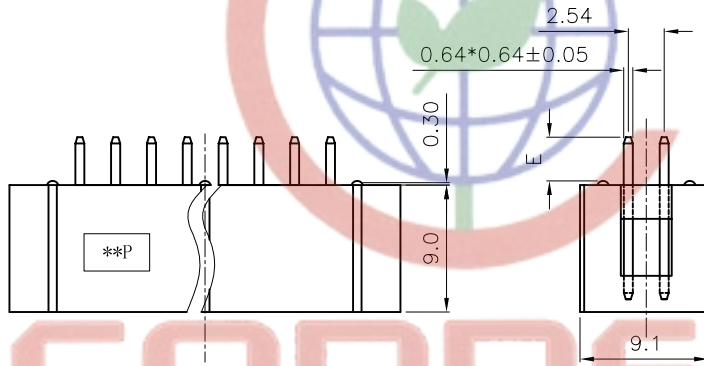
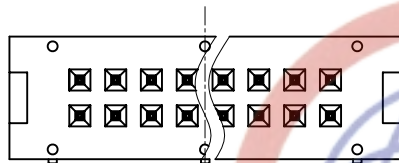

Dimension

Position	A	B	C	30	40	50	60	64
10	20.30	18.10	10.16	45.70	43.50	35.56		
12	22.84	20.64	12.70	50.78	48.58	40.64		
14	25.38	23.18	15.24	58.40	56.20	48.26		
16	27.92	25.72	17.78	66.02	63.82	55.88		
20	33.00	30.80	22.86	83.80	81.60	73.66		
26	40.62	38.42	30.48	101.78	99.58	91.54		

NOTES:

- ELECTRICAL CHARACTERISTICS:
 - CONTACT RESISTANCE: 20mΩ Max. INITIAL.
 - DIELECTRIC WITHSTANDING VOLTAGE: 500V AC(rms) FOR 1 MINUTE.
 - INSULATION RESISTANCE: 1000MΩ Min.
- ENVIRONMENT CHARACTERISTICS:
 - TEMPERATURE RANGE: -45°C~+105°C.
- PART NUMBER: DS1013
- PRODUCT NUMBER CODE:

DS1013- X X X X X X

 - DIM. H TYPE (FOR ELEVATOR ONLY)
 - 7.50
 - 9.50
 - DIM. E TYPE (FOR V/T ONLY)
 - 3.10
 - 8.00
 - HOUSING COLOR
 - B: BLACK
 - W: WHITE
 - U: BLUE
 - A: GRAY
 - CONTACT PLATING
 - Si: FULL GOLD FLASH
 - MOUNTING TYPE
 - S: V/T TYPE
 - R: R/A TYPE
 - E: Elevator TYPE
 - No. OF CONTACTS
 - 08 10 14 16
 - 20 26 30 34
 - 40 50 60 64

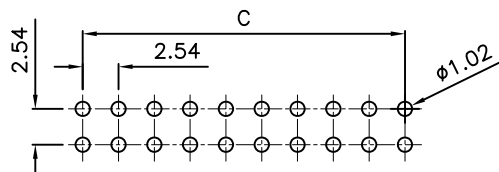

RECOMMEND PCB LAYOUT(TOLERANCE=±0.05)

GENERAL TOLERANCE	ANGLE TOLERANCE	PROJECTION	TITLE	BOX HEADER PITCH 2.54mm
X. ±0.60	X. ±5°	mm		
.X ±0.38	.X ±3°	A4	SERIES	DS1013 SERIES
.XX ±0.25	.XX ±2°			
DRAWING TYPE	CUSTOMER	晨翔电子有限公司 CONNFLY CONNFLY ELECTRONIC CO. LTD		
SCALE	1:1	SHEET	1 OF 1	
DRAWING NO.	C-DS1013-XXXX-B			

REV.	DESCRIPTION	DRAWN	CHECKED	APPROVED
A	NEW RELEASE	LJH 09/20/05'		

NOTES:

- ELECTRICAL CHARACTERISTICS:
 - CONTACT RESISTANCE: 20mΩ Max. INITIAL.
 - DIELECTRIC WITHSTANDING VOLTAGE: 500V AC(rms) FOR 1 MINUTE.
 - INSULATION RESISTANCE: 1000MΩ Min.
- ENVIRONMENT CHARACTERISTICS:

TEMPERATURE RANGE: -45°C~+105°C.
- PART NUMBER: DS1013
- PRODUCT NUMBER CODE:

Dimension

Position	A	B	C
10	20.30	18.10	10.16
12	22.84	20.64	12.70
14	25.38	23.18	15.24
16	27.92	25.72	17.78
20	33.00	30.80	22.86
26	40.62	38.42	30.48
30	45.70	43.50	35.56
34	50.78	48.58	40.64
40	58.40	56.20	48.26
50	71.10	68.90	60.96
60	83.80	81.60	73.66
64	88.88	86.68	78.74

DS1013- X X X X

- PACKING TYPE
 - A: TUBE
 - R: TAPE ON REEL
 - T: TRAY
- PICK UP SUPPORT
 - S: W/ PICK UP
 - X: W/O PICK UP
- CONTACT PLATING
 - Si: FULL GOLD FLASH
- MOUNTING TYPE
 - M: SMT TYPE
- No.OF CONTACTS
 - 08 10 14 16
 - 20 26 30 34
 - 40 50 60 64
- SERIES No. DS1013

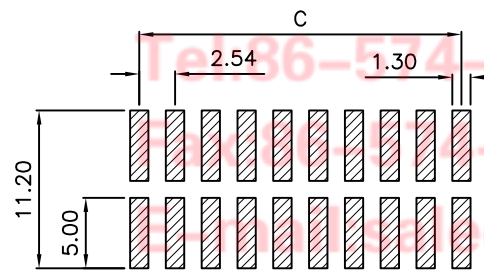
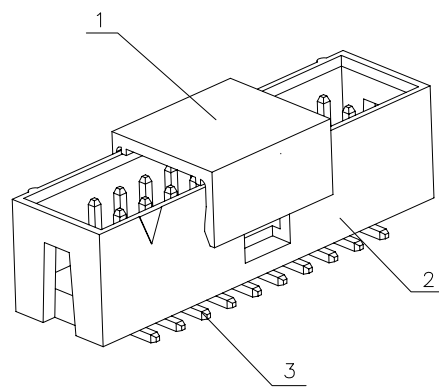
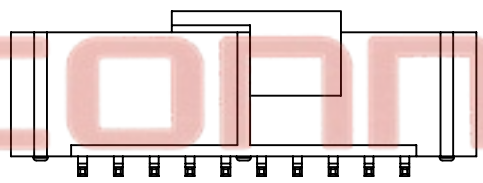
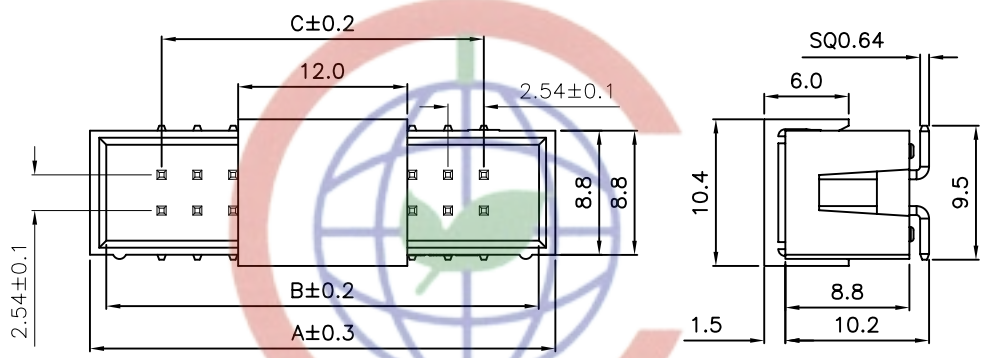

RECOMMEND PCB LAYOUT
TOLERANCE=±0.05

GENERAL TOLERANCE		ANGLE TOLERANCE	
X.	±0.60	X.	±5°
.X	±0.38	.X	±3°
.XX	±0.25	.XX	±2°

PROJECTION	TITLE	BOX HEADER PITCH 2.54mm	
UNITS	mm	SMT TYPE	
SHEET SIZE	A4	SERIES	DS1013 SERIES

ITEM	PART NAME	PART NO.	MATERILAS	FINISHED
3	CONTACT		COPPER ALLOY	GOLD FLASH
2	HOUSING		NYLON-46	GLASS FILLED, UL 94 V-0
1	PICK UP		NYLON-46	UL 94 V-2

DRAWING TYPE	CUSTOMER
SCALE	1:1
DRAWING NO.	C-DS1013-XXMXXXX

晨翔电子有限公司
CONNFLY CONNFLY ELECTRONIC CO. LTD

Tel: 86-574-63508787
 Fax: 86-574-63510817
 Email: sales@zhenqin.com.cn
 Http://www.connfly.com