

Power OFF Delay Timer

DIN W48 × H48mm Solid-State, Power OFF Delay TIMER

■ Features

- Time setting range
(AT8PSN : 0.5~10sec, AT8PM : 0.5~10min)
- Simple time setup and direct read of time range
- Power supply : 100~120VAC 50/60Hz, 200~240VAC 50/60Hz
100/110VDC, 48VDC, 24VDC
- Application : Protect circuit when momentary power failure and start it again.



⚠ Please read "Caution for your safety" in operation manual before using.

■ Ordering information

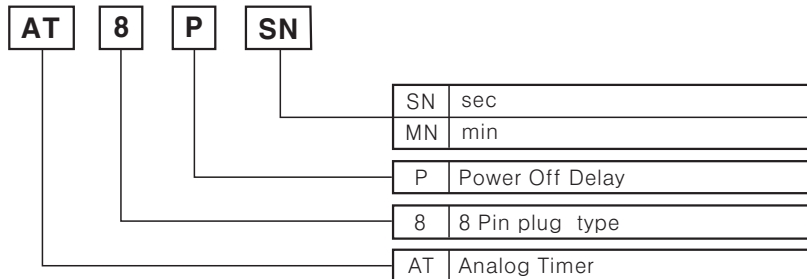

■ Specifications

Model		AT8PSN	AT8PMN
Function		Power OFF Delay	
Control time setting range		0.5, 1, 5, 10sec	0.5, 1, 5, 10min
Power supply		<ul style="list-style-type: none"> • 100~120VAC 50/60Hz • 100/110VDC 	<ul style="list-style-type: none"> • 200~240VAC 50/60Hz • 48VDC • 24VDC
Allowable voltage range		90 ~ 110% of rated voltage	
Power consumption		<ul style="list-style-type: none"> • Approx. 0.5VA(120VAC 60Hz), Approx. 0.9VA(240VAC 60Hz) • Approx. 0.5W(110VDC), Approx. 0.2W(48VDC), Approx. 0.1W(24VDC) 	
Timing operation		Power ON Start type	
Control output	Contact type	Time limit DPDT(2c)	
	Contact capacity	250VAC 3A resistive load	
Relay life cycle	Mechanical	Min.10,000,000 times	
	Electrical	Min. 100,000 times(250VAC 3A resistive load)	
Repeat error		Max. ±0.3%	
Setting error		Max. ±5% ±0.05sec.	
Voltage error		Max. ±0.5%	
Temperature error		Max. ±2%	
Insulation resistance		100MΩ (at 500VDC mega)	
Dielectric strength		2000VAC 50/60Hz for 1 minute	
Noise strength		±2kV the square wave noise(pulse width:1μs) by the noise simulator	
Vibration	Mechanical	0.75mm amplitude at frequency of 10 ~ 55Hz in each of X, Y, Z directions for 1 hours	
	Malfunction	0.5mm amplitude at frequency of 10 ~ 55Hz in each of X, Y, Z directions for 10 minutes	
Shock	Mechanical	300m/s ² (Approx. 30G) in X, Y, Z directions 3 times	
	Malfunction	100m/s ² (Approx. 10G) in X, Y, Z directions 3 times	
Ambient temperature		-10 ~ 55℃ (at non-freezing status)	
Storage temperature		-25 ~ 65℃ (at non-freezing status)	
Ambient humidity		35 ~ 85%RH	
Unit weight		Approx. 98g	Approx. 105g

(A) Counter

(B) Timer

(C) Temp. controller

(D) Power controller

(E) Panel meter

(F) Tacho/Speed/Pulse meter

(G) Display unit

(H) Sensor controller

(I) Switching power supply

(J) Proximity sensor

(K) Photo electric sensor

(L) Pressure sensor

(M) Rotary encoder

(N) Stepping motor & Driver & Controller

(O) Graphic panel

(P) Field network device

(Q) Production stoppage models & replacement

AT8PSN / AT8PMN

Connections

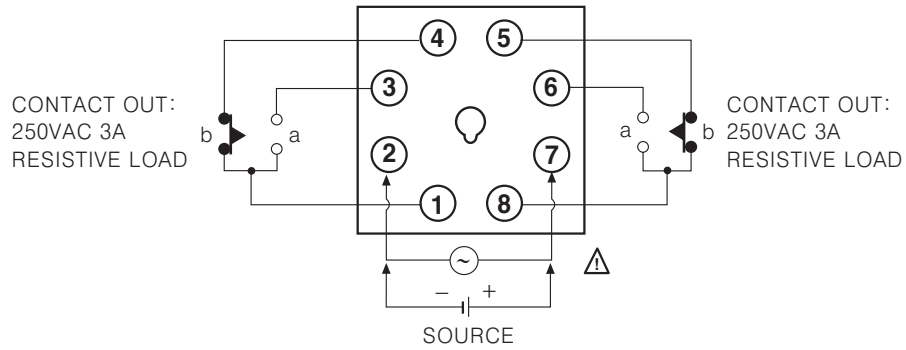

Dimensions

Bracket

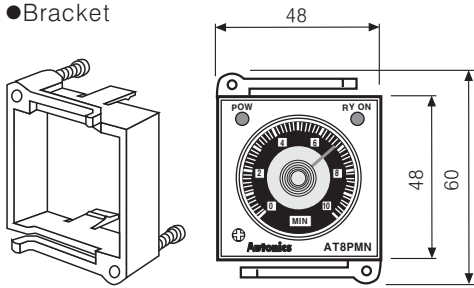

Panel cut-out

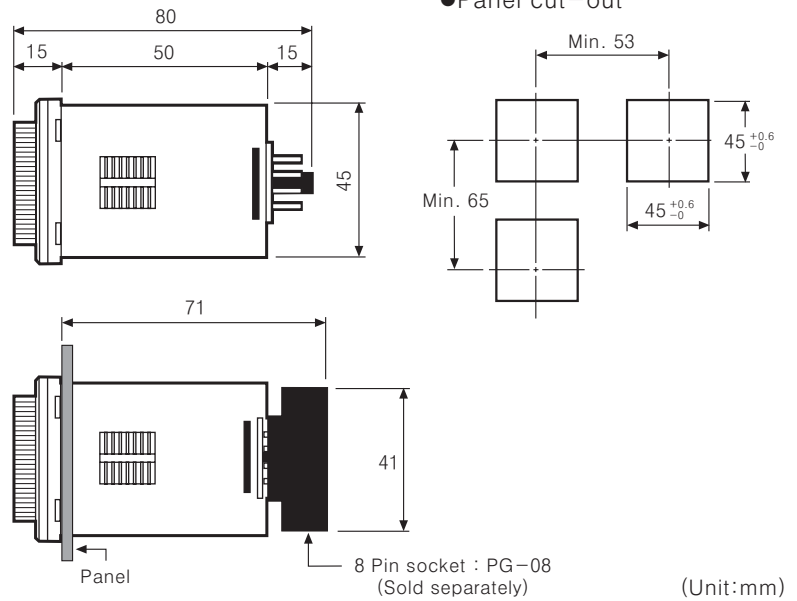

(Unit:mm)

Front panel identification

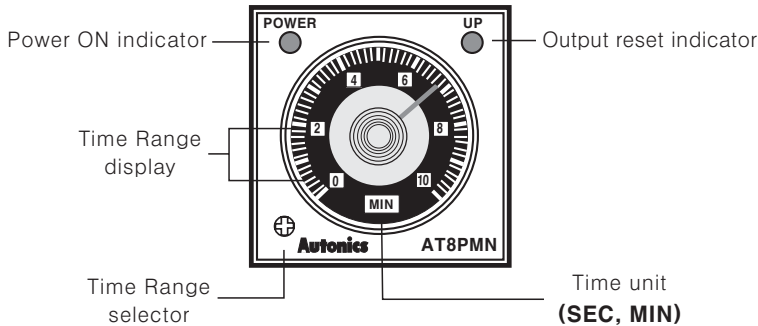

Time specification

Unit	SEC	MIN
Setting time range(T)	0 ~ 0.5	
	0 ~ 1.0	
	0 ~ 5	
	0 ~ 10	
Min. time to supply the power	0.1sec	2sec

Output operation mode

Contact a turns ON when the power applied and then turns off after setting time(T) is passed when the power off.

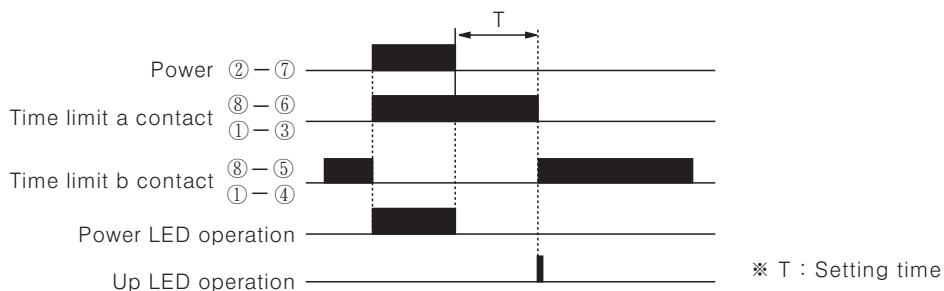

※ T : Setting time

Power OFF Delay Timer

■ Proper usage

◎ Power

This product is power OFF delay timer, the time of min. power supply is 0.1sec. for AT8PSN type and 2sec. for AT8PMN. Therefore be sure that this product will operation after power off.

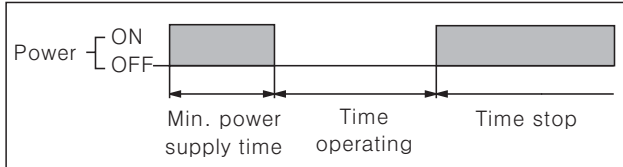

※ Please use the power within rating power and apply.

◎ Noise

1) We test 2kV, Pulse width $1\mu\text{s}$ against impulse voltage between power terminals and 1kV, Pulse width $1\mu\text{s}$ at noise simulator against external noise voltage. Please install MP condensor ($0.1\sim 1\mu\text{F}$) or Oil condensor between power teminals when over Impulse noise voltage occurs.

2) When testing dielectric voltage and insulation resistance of the control panel with this unit installed.

- Please isolate this unit from the circuit of control panel.
- Please make all terminals of this unit short-circuited.
(It prevents the damage of inner circuit.)

◎ Environment

Please avoid the following places:

- A place where this product may be damaged by strong impact or vibration.
- A place where corrosive gas or flammable gas, water, oil and dust exist.
- A place where magnetic and electrical noise occur.
- A place where high temperature and humidity are beyond rated specification.
- A place where there are strong alkalis and acids.
- A place where there are direct rays of sun.

(A)
Counter

(B)
Timer

(C)
Temp.
controller

(D)
Power
controller

(E)
Panel
meter

(F)
Tacho/
Speed/
Pulse
meter

(G)
Display
unit

(H)
Sensor
controller

(I)
Switching
power
supply

(J)
Proximity
sensor

(K)
Photo
electric
sensor

(L)
Pressure
sensor

(M)
Rotary
encoder

(N)
Stepping
motor &
Driver &
Controller

(O)
Graphic
panel

(P)
Field
network
device

(Q)
Production
stoppage
models &
replacement