



EMC TEST REPORT
for
VOLTRONIC POWER TECHNOLOGY CORP.

UPS
Model Number: Galleon 2K, Galleon 3K

Prepared for : VOLTRONIC POWER TECHNOLOGY CORP.
Address : 12/F-2, No.396, Sec.1, Nei-Hu Road, Taipei, Taiwan R.O.C.

Prepared by : Shenzhen EMTEK Co., Ltd
Address : Bldg 69, Majialong Industry Zone,
Nanshan District, Shenzhen, Guangdong, China

Tel: (0755) 26954280
Fax: (0755) 26954282

Report Number : E0902005E-1
Date of Test : October 17, 2011 to October 19, 2011
Date of Report : October 19, 2011

TABLE OF CONTENT

Description	Page
1. GENERAL INFORMATION.....	6
1.1. Description of Device (EUT).....	6
1.2. Description of Test Facility.....	7
1.3. Measurement Uncertainty.....	7
2. MEASURING DEVICE AND TEST EQUIPMENT	8
2.1. For Power Line Conducted Emission	8
2.2. For Radiated Emission Measurement	8
2.3. For Harmonic Current& Flick Measurement.....	8
2.4. For Electrostatic Discharge Immunity Test.....	8
2.5. For RF Strength Susceptibility Test	9
2.6. For Electrical Fast Transient /Burst Immunity Test.....	9
2.7. For Surge Immunity Test.....	9
2.8. For Injected Current Susceptibility Test.....	9
2.9. For Magnetic Field Immunity Test.....	10
2.10. For Voltage Dips and Interruptions Test.....	10
2.11. Low Frequency Signals Test.....	10
3. POWER LINE CONDUCTED EMISSION MEASUREMENT	11
3.1. Block Diagram of Test Setup	11
3.2. Measuring Standard	11
3.3. EUT Configuration on Measurement.....	11
3.4. Operating Condition of EUT.....	11
3.5. Test Procedure.....	12
3.6. Measuring Results.....	12
4. RADIATED EMISSION MEASUREMENT.....	13
4.1. Block Diagram of Test	13
4.2. Measuring Standard	13
4.3. Radiated Emission Limits	14
4.4. EUT Configuration on Test.....	14
4.5. Operating Condition of EUT.....	14
4.6. Test Procedure.....	14
4.7. Measuring Results.....	14
5. HARMONIC CURRENT EMISSION MEASUREMENT.....	15
5.1 Block Diagram of Test Setup	15
5.2 Measuring Standard.....	15
5.3 Operation Condition of EUT.....	15
5.4 Measuring Results.....	15
6. VOLTAGE FLUCTUATION AND FLICKER MEASUREMENT	22
6.1 Block Diagram of Test Setup	22
6.2 Measuring Standard	22
6.3 Operation Condition of EUT.....	22
6.4 Measuring Results.....	22
7. ELECTROSTATIC DISCHARGE IMMUNITY TEST.....	25

7.1 Block Diagram of Test Setup.....	25
7.2 Test Standard	25
7.3 Severity Levels and Performance Criterion	25
7.4 EUT Configuration	26
7.5 Operating Condition of EUT	26
7.6 Test Procedure	26
7.7 Test Results.....	27
8. RF FIELD STRENGTH SUSCEPTIBILITY TEST	29
8.1 Block Diagram of Test.....	29
8.2 Test Standard	29
8.3 Severity Levels and Performance Criterion	30
8.4 EUT Configuration on Test	30
8.5 Operating Condition of EUT	30
8.6 Test Procedure	30
8.7 Test Results.....	31
9. ELECTRICAL FAST TRANSIENT/BURST IMMUNITY TEST	33
9.1 Block Diagram of Test Setup.....	33
9.2 Test Standard	33
9.3 Severity Levels and Performance Criterion	34
9.4 EUT Configuration	34
9.5 Operating Condition of EUT	34
9.6 Test Procedure	34
9.7 Test Result	35
10. SURGE IMMUNITY TEST	37
10.1 Block Diagram of Test Setup.....	37
10.2 Test Standard	37
10.3 Severity Levels and Performance Criterion	37
10.4 EUT Configuration	38
10.5 Operating Condition of EUT	38
10.6 Test Procedure	38
10.7 Test Result	38
11. INJECTED CURRENTS SUSCEPTIBILITY TEST	40
11.1 Block Diagram of Test Setup.....	40
11.2 Test Standard.....	40
11.3 Severity Levels and Performance Criterion.....	40
11.4 EUT Configuration	41
11.5 Operating Condition of EUT	41
11.6 Test Procedure.....	41
11.7 Test Results	41
12. MAGNETIC FIELD SUSCEPTIBILITY TEST	43
12.1 Block Diagram of Test.....	43
12.2 Test Standard	43
12.3 Severity Levels and Performance Criterion	43
12.4 EUT Configuration on Test	44
12.5 Test Procedure	44
12.6 Test Results.....	44
13. VOLTAGE DIPS AND INTERRUPTIONS TEST	46
13.1 Block Diagram of Test Setup.....	46

13.2 Test Standard	46
13.3 Severity Levels and Performance Criterion	46
13.4 EUT Configuration	47
13.5 Operating Condition of EUT	47
13.6 Test Procedure	47
13.7 Test Result	47
14. LOW FREQUENCY signals TEST	49
14.1 Block Diagram of Test Setup.....	49
14.2 Test Standard	49
14.3 Operating Condition of EUT	49
14.4 Test Results.....	50
15. test PHOTOGRAPH.....	52
15.1 Photo of Conducted Emission Measurement	52
15.2 Photo of Radiation Emission Measurement	52
15.3 Photos of Harmonic / Flicker Measurement.....	53
15.4 Photos of Electrostatic Discharge Test	53
15.5 Photos of RF Field Strength susceptibility Test	54
15.6 Photo of Electrical Fast Transient /Burst Test	54
15.7 Photo of Surge Test.....	55
15.8 Photo of Injected Currents Susceptibility Test	55
15.9 Photo of Magnetic Field Immunity Test.....	56
15.10 Photo of Voltage Dips and Interruption Immunity Test.....	56
APPENDIX I (8 Pages)	
APPENDIX II (8 Pages)	
APPENDIX III (Photos of EUT) (4 Pages)	

TEST REPORT VERIFICATION

Applicant : VOLTRONIC POWER TECHNOLOGY CORP.
 Manufacturer : VOLTRONIC POWER (SHENZHEN) TECHNOLOGY CORP.
 EUT : UPS
 Model Number : Galleon 2K, Galleon 3K
 Input Voltage : 208-240V~, 50/60Hz

Measurement Procedure Used:

EN62040-2: 2006
 EN61000-4-2:2009, EN61000-4-3:2006+A1:2008+A2:2010 , EN61000-4-4:2004+A1:2010 ,
 EN61000-4-5:2006, EN61000-4-6:2009, EN61000-4-8:2010, EN61000-4-11: 2004,
 EN61000-2-2: 2002, EN61000-3-2:2006+A1:2009+A2:2009, EN61000-3-3:2008

The device described above is tested by SHENZHEN EMTEK CO., LTD. to determine the maximum emission levels emanating from the device and the severe levels of the device can endure and its performance criterion. The measurement results are contained in this test report and SHENZHEN EMTEK CO., LTD. is assumed full of responsibility for the accuracy and completeness of these measurements. Also, this report shows that the EUT (Equipment Under Test) is technically compliant with the EN 62040-2 requirements.

This report applies to above tested sample only and shall not be reproduced in part without written approval of SHENZHEN EMTEK CO., LTD.

Date of Test : October 17, 2011 to October 19, 2011

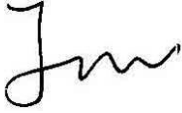
Prepared by : 
 (Engineer)

Reviewer : 
 (Project Manager)



Approved & Authorized Signer : 
 (Manager)

1. GENERAL INFORMATION

1.1. Description of Device (EUT)

EUT : UPS

Model Number : Galleon 2K, Galleon 3K

Test voltage : AC 230V/50Hz,

Power : GALLEON 2K: 2000VA,
GALLEON 3K: 3000VA

Applicant : VOLTRONIC POWER TECHNOLOGY CORP.

Address : 12/F-2, No.396, Sec.1, Nei-Hu Road, Taipei, Taiwan R.O.C.

Manufacturer : VOLTRONIC POWER (SHENZHEN) TECHNOLOGY CORP.

Address : 1-4F, Building 5, YuSheng Industrial Park, No.467, Section
Xixiang, National Highway 107, Xixiang, Bao An District,
Shenzhen, China

Date of receiver : October 17, 2011

Date of Test : October 17, 2011 to October 19, 2011

1.2. Description of Test Facility

Site Description

Emc Lab. : Accredited By Cnas, 2010.10.29
The Certificate Is Valid Until 2013.10.28
The Laboratory Has Been Assessed And Proved To Be In
Compliance With Cnas-Cl01:2006(Identical To
Iso/Iec17025:2005)
THE CERTIFICATE REGISTRATION NUMBER IS L2291.

Accredited By TUV Rheinland Shenzhen 2010.5.25
The Laboratory Has Been Assessed According To The
Requirements ISO/IEC 17025.

Accredited By FCC, October 28, 2010
The Certificate Registration Number Is 406365.

Accredited By Industry Canada, March 05, 2010
The Certificate Registration Number Is 46405-4480.

Name Of Firm : SHENZHEN EMTEK CO., LTD
Site Location : Bldg 69, Majialong Industry Zone,
Nanshan District, Shenzhen, Guangdong, China

1.3. Measurement Uncertainty

Radiation Uncertainty : $U_r = \pm 1.6656\text{dB}$

Conduction Uncertainty : $U_c = \pm 1.4118\text{dB}$

2. MEASURING DEVICE AND TEST EQUIPMENT

2.1.For Power Line Conducted Emission

Item	Equipment	Manufacturer	Model No.	Serial No.	Last Cal.	Cal. Interval
1.	Test Receiver	Rohde & Schwarz	ESCS30	828985/018	May 29, 2011	1 Year
2.	L.I.S.N	Rohde & Schwarz	ESH2-Z5	834549/005	May 29, 2011	1 Year
3.	50 Coaxial Switch	Anritsu	MP59B	M20531	N/A	N/A
4.	Pulse Limiter	Rohde & Schwarz	ESH3-Z2	100006	May 29, 2011	1 Year
5.	Voltage Probe	Rohde & Schwarz	TK9416	N/A	May 29, 2011	1 Year

2.2.For Radiated Emission Measurement

Item	Equipment	Manufacturer	Model No.	Serial No.	Last Cal.	Cal. Interval
1	EMI Test Receiver	Rohde & Schwarz	ESU	1302.6005.26	May 29, 2011	1 Year
2	Pre-Amplifier	HP	8447D	2944A07999	May 29, 2011	1 Year
3	Bilog Antenna	Schwarz beck	VULB9163	142	May 29, 2011	1 Year
4	Loop Antenna	ARA	PLA-1030/B	1029	May 29, 2011	1 Year
5	Horn Antenna	Schwarzbeck	BBHA 9170	BBHA91703 99	May 29, 2011	1 Year
6	Horn Antenna	Schwarzbeck	BBHA 9120	D143	May 29, 2011	1 Year

2.3.For Harmonic Current& Flick Measurement

Item	Equipment	Manufacturer	Model No.	Serial No.	Last Cal.	Cal. Interval
1.	Power Frequency Test System	EMTEST	DPA500	U05261005 06	May 29, 2011	1 Year
2.	PC	N/A	P2L97	N/A	May 29, 2011	N/A

2.4.For Electrostatic Discharge Immunity Test

Item	Equipment	Manufacturer	Model No.	Serial No.	Last Cal.	Cal. Interval
1.	ESD Tester	EM TEST	ESD 30C	V0256100500	May 29, 2011	1 Year

2.5. For RF Strength Susceptibility Test

Item	Equipment	Manufacturer	Model No.	Serial No.	Last Cal.	Cal. Interval
1.	RF Power Meter. Dual Channel	BOONTON	4232A	10539	May 29, 2011	1 Year
2.	50ohm Diode Power Sensor	BOONTON	51011EMC	34236/34238	May 29, 2011	1 Year
3.	Broad-Band Horn Antenna	SCHWARZBEC K	BBHA 9120 L3F	332	May 29, 2011	1 Year
4.	Power Amplifier	PRANA	AP32MT215	N/A	May 29, 2011	1 Year
5.	Power Amplifier	MILMEGA	AS0102-55	N/A	May 29, 2011	1 Year
6.	Signal Generator	AEROFLEX	2023B	N/A	May 29, 2011	1 Year
7.	Field Strength Meter	HOLADAY	HI-6005	N/A	May 29, 2011	1 Year
8.	RS232 Fiber Optic Modem	HOLADAY	HI-4413P	N/A	May 29, 2011	1 Year
9.	Log.-Per. Antenna	SCHWARZBEC K	VULP 9118E	N/A	May 29, 2011	1 Year

2.6. For Electrical Fast Transient /Burst Immunity Test

Item	Equipment	Manufacturer	Model No.	Serial No.	Last Cal.	Cal. Interval
1.	Burst Tester	HAEFELY	PEFT4010	080981-16	May 29, 2011	1Year
2.	Coupling Clamp	HAEFELY	IP-4A	147147	May 29, 2011	1Year

2.7. For Surge Immunity Test

Item	Equipment	Manufacturer	Model No.	Serial No.	Last Cal.	Cal. Interval
1.	Surge Tester	EM TEST	VCS 500M6T	V0256100503	May 29, 2011	1Year

2.8. For Injected Current Susceptibility Test

Item	Equipment	Manufacturer	Model No.	Serial No.	Last Cal.	Cal. Interval
1.	Simulator	EMTEST	CWS500C	0900-12	May 29, 2011	1Year
2.	CDN	EMTEST	CDN-M2	5100100100	May 29, 2011	1Year
3.	CDN	EMTEST	CDN-M3	0900-11	May 29, 2011	1Year
4.	Injection Clamp	EMTEST	F-2031-23 MM	368	May 29, 2011	1Year
5.	Attenuator	EMTEST	ATT6	0010222A	May 29, 2011	1Year

2.9. For Magnetic Field Immunity Test

Item	Equipment	Manufacturer	Model No.	Serial No.	Last Cal.	Cal. Interval
1.	Magnetic Field Tester	HAEFELY	MAG100	250040.1	May 29, 2011	1 Year

2.10. For Voltage Dips and Interruptions Test

Item	Equipment	Manufacturer	Model No.	Serial No.	Last Cal.	Cal. Interval
1.	Dips Tester	HAEFELY	Pline1610	083732-12	May 29, 2011	1 Year

2.11. Low Frequency Signals Test

Item	Equipment	Manufacturer	Model No.	Serial No.	Last Cal.	Cal. Interval
2.	Programmable AC Source	CHROMA	65930	/	May 29, 2011	1 Year

3. POWER LINE CONDUCTED EMISSION MEASUREMENT

3.1. Block Diagram of Test Setup

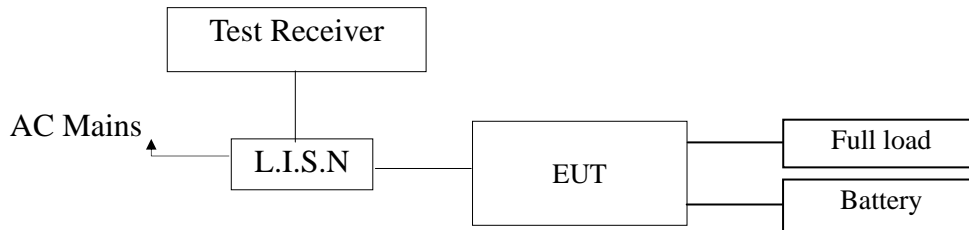

(EUT: UPS)

3.2. Measuring Standard

EN62040-2: 2006 Category C2
Power Line Conducted Emission Limits

Frequency (MHz)	Limit (dB μ V)	
	Quasi-peak Level	Average Level
0.15 ~ 0.50	79	66
0.50 ~ 30.00	73	60
NOTE1- The lower limit shall apply at the transition frequencies.		

3.3. EUT Configuration on Measurement

The following equipments are installed on Conducted Emission Measurement to meet EN 62040-2 requirements and operating in a manner which tends to maximize its emission characteristics in a normal application.

UPS (EUT)
 Model Number : Galleon 2K, Galleon 3K
 Serial Number : N/A

3.4. Operating Condition of EUT

- 3.4.1. Setup the EUT as shown on Section 3.1.
- 3.4.2. Turn on the power of all equipments.
- 3.4.3. Let the EUT work in measuring mode (Line mode/ Battery mode) and measure it.

3.5. Test Procedure

The EUT is put on the plane 0.8m high above the ground by insulating support and connected to the AC mains through Line Impedance Stability Network (L.I.S.N). This provided a 50ohm coupling impedance for the tested equipments. Both sides of AC line are investigated to find out the maximum conducted emission according to the EN 62040-2 regulations during conducted emission measurement. The bandwidth of the field strength meter (R&S Test Receiver ESCS30) is set at 9KHz in 150KHz~30MHz and 200Hz in 9KHz~150KHz. The frequency range from 150kHz to 30MHz is investigated. All the scanning waveform is put in Appendix I.

3.6. Measuring Results

PASS.

Please reference to the following page

4. RADIATED EMISSION MEASUREMENT

4.1. Block Diagram of Test

4.1.1. Block diagram of connection between the EUT and simulators



(EUT: UPS)

4.1.2. Block diagram of test setup (In chamber)

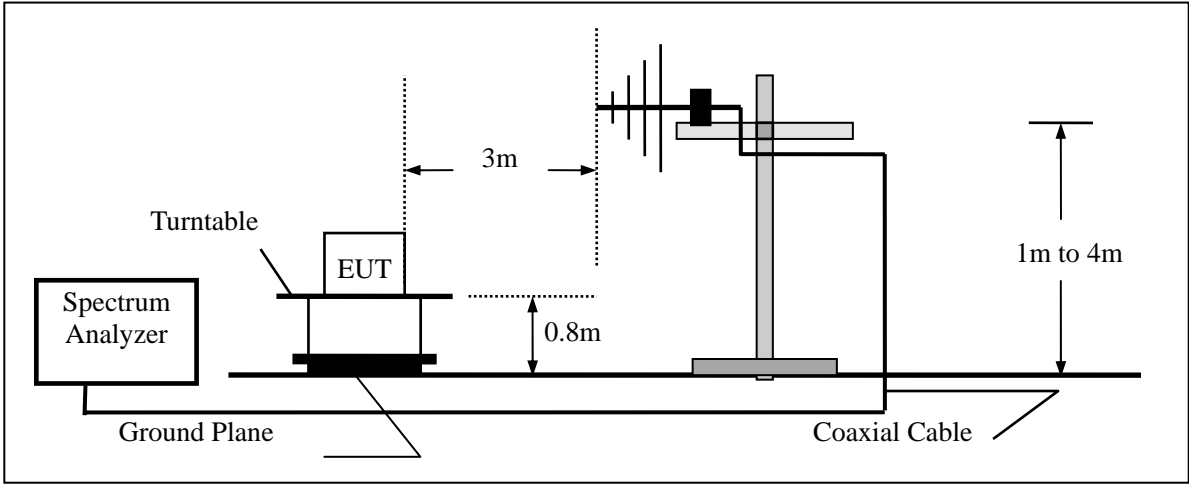

GROUND REFERENCE PLANE

(EUT: UPS)

4.2. Measuring Standard

EN62040-2: 2006 Category C2

4.3.Radiated Emission Limits

All emanations from device or system, including any network of conductors and apparatus connected thereto, shall not exceed the level of field strengths specified below:

FREQUENCY (MHz)	DISTANCE (Meters)	FIELD STRENGTHS LIMIT (dB μ V/m)
30 ~ 230	3	40
230 ~ 1000	3	47

Note: (1) The smaller limit shall apply at the combination point between two frequency bands.
 (2) Distance refers to the distance in meters between the measuring instrument antenna and the closed point of any part of the EUT.

4.4.EUT Configuration on Test

The EN 62040-2 regulations test method must be used to find the maximum emission during radiated emission measurement.

4.5.Operating Condition of EUT

4.5.1.Turn on the power.

4.5.2.After that, let the EUT work in test mode (Line mode/Battery mode) and measure it.

4.6.Test Procedure

The EUT is placed on a turn table which is 0.8 meter high above the ground. The turn table can rotate 360 degrees to determine the position of the maximum emission level. The EUT is set 3 meters away from the receiving antenna which is mounted on a antenna tower. The antenna can be moved up and down from 1 to 4 meters to find out the maximum emission level. Bilog antenna (calibrated by Dipole Antenna) is used as a receiving antenna. Both horizontal and vertical polarization of the antenna are set on test.

The bandwidth of the Receiver (ESCS30) is set at 120kHz.
 All the scanning curves are attached in Appendix II.

4.7.Measuring Results

PASS.

The frequency range from 30MHz to 1000MHz is investigated.

Please reference to the following page

5. HARMONIC CURRENT EMISSION MEASUREMENT

5.1 Block Diagram of Test Setup

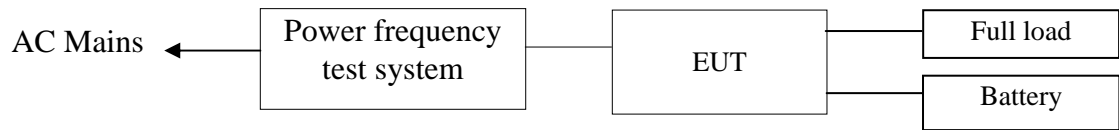

(EUT: UPS)

5.2 Measuring Standard

EN61000-3-2:2006+A1:2009+A2:2009

5.3 Operation Condition of EUT

Same as Section 3.4, except the test setup replaced as Section 5.1.

5.4 Measuring Results

PASS.

E. U. T. Result of GALLEON 2K

Check harmonics 2..40 [exception odd 21..39]:

Harmonic(s) > 150%:	
Order (n):	None
Harmonic(s) with average > 100%:	
Order (n):	None

Check odd harmonics 21..39:

All Partial Odd Harmonics below partial limits.	
Harmonic(s) > 150%:	
Order (n):	None
Harmonic(s) with average > 150%:	
Order (n):	None

Power Source Result

First dataset out of limit:	
DS (time):	None
Harmonic(s) out of limit:	
Order (n):	None

Average harmonic current results

Hn	I _{eff} [A]	I _{eff} [%]	Limit [A]	Result
1	4.578	100.000		
2	61.976E-3	1.354	1.08	PASS
3	71.460E-3	1.561	2.30	PASS
4	12.004E-3	0.262	430.00E-3	PASS
5	43.075E-3	0.941	1.14	PASS
6	10.657E-3	0.233	300.00E-3	PASS
7	58.979E-3	1.288	770.00E-3	PASS
8	14.794E-3	0.323	230.00E-3	PASS
9	68.090E-3	1.487	400.00E-3	PASS
10	15.704E-3	0.343	184.00E-3	PASS
11	67.611E-3	1.477	330.00E-3	PASS
12	16.305E-3	0.356	153.33E-3	PASS
13	68.856E-3	1.504	210.00E-3	PASS
14	26.631E-3	0.582	131.43E-3	PASS
15	93.150E-3	2.035	150.00E-3	PASS
16	42.229E-3	0.922	115.00E-3	PASS
17	90.259E-3	1.972	132.35E-3	PASS
18	33.785E-3	0.738	102.22E-3	PASS
19	34.993E-3	0.764	118.42E-3	PASS
20	22.685E-3	0.496	92.00E-3	PASS
21	21.589E-3	0.472	160.71E-3	PASS
22	16.059E-3	0.351	83.64E-3	PASS
23	15.082E-3	0.329	146.74E-3	PASS
24	9.388E-3	0.205	76.66E-3	PASS
25	12.512E-3	0.273	135.00E-3	PASS
26	4.048E-3	0.088	70.77E-3	PASS
27	7.313E-3	0.160	124.99E-3	PASS
28	2.245E-3	0.049	65.71E-3	PASS
29	4.824E-3	0.105	116.39E-3	PASS
30	1.549E-3	0.034	61.33E-3	PASS
31	2.804E-3	0.061	108.87E-3	PASS
32	1.055E-3	0.023	57.50E-3	PASS
33	3.435E-3	0.075	102.27E-3	PASS
34	468.313E-6	0.010	54.12E-3	PASS
35	2.649E-3	0.058	96.44E-3	PASS
36	661.293E-6	0.014	51.11E-3	PASS
37	2.355E-3	0.051	91.21E-3	PASS
38	1.010E-3	0.022	48.42E-3	PASS
39	1.710E-3	0.037	86.53E-3	PASS
40	688.092E-6	0.015	46.00E-3	PASS

Maximum harmonic current results

Hn	I _{eff} [A]	I _{eff} [%]	Limit [A]	Result
1	4.602	100.000		
2	72.719E-3	1.580	1.62	PASS
3	77.784E-3	1.690	3.45	PASS
4	16.292E-3	0.354	645.00E-3	PASS
5	47.787E-3	1.038	1.71	PASS
6	14.366E-3	0.312	450.00E-3	PASS
7	62.910E-3	1.367	1.15	PASS
8	17.459E-3	0.379	345.00E-3	PASS
9	71.558E-3	1.555	600.00E-3	PASS
10	18.271E-3	0.397	276.00E-3	PASS
11	72.772E-3	1.581	495.00E-3	PASS
12	19.602E-3	0.426	229.99E-3	PASS
13	73.017E-3	1.587	315.00E-3	PASS
14	34.785E-3	0.756	197.15E-3	PASS
15	98.905E-3	2.149	225.00E-3	PASS
16	51.271E-3	1.114	172.50E-3	PASS
17	103.279E-3	2.244	198.52E-3	PASS
18	41.708E-3	0.906	153.33E-3	PASS
19	42.907E-3	0.932	177.63E-3	PASS
20	26.858E-3	0.584	138.00E-3	PASS
21	28.040E-3	0.609	160.71E-3	PASS
22	18.585E-3	0.404	125.46E-3	PASS
23	20.563E-3	0.447	146.74E-3	PASS
24	11.062E-3	0.240	114.99E-3	PASS
25	14.631E-3	0.318	135.00E-3	PASS
26	5.054E-3	0.110	106.16E-3	PASS
27	9.469E-3	0.206	124.99E-3	PASS
28	2.883E-3	0.063	98.57E-3	PASS
29	5.966E-3	0.130	116.39E-3	PASS
30	1.947E-3	0.042	92.00E-3	PASS
31	3.697E-3	0.080	108.87E-3	PASS
32	1.317E-3	0.029	86.25E-3	PASS
33	3.977E-3	0.086	102.27E-3	PASS
34	880.842E-6	0.019	81.18E-3	PASS
35	3.101E-3	0.067	96.44E-3	PASS
36	973.429E-6	0.021	76.66E-3	PASS
37	2.832E-3	0.062	91.21E-3	PASS
38	1.261E-3	0.027	72.63E-3	PASS
39	2.040E-3	0.044	86.53E-3	PASS
40	885.305E-6	0.019	69.00E-3	PASS

E. U. T. Result of GALLEON 3K

Check harmonics 2..40 [exception odd 21..39]:

Harmonic(s) > 150%:	
Order (n):	None
Harmonic(s) with average > 100%:	
Order (n):	None

Check odd harmonics 21..39:

All Partial Odd Harmonics below partial limits.	
Harmonic(s) > 150%:	
Order (n):	None
Harmonic(s) with average > 150%:	
Order (n):	None

Power Source Result

First dataset out of limit:	
DS (time):	None
Harmonic(s) out of limit:	
Order (n):	None

Average harmonic current results

Hn	I _{eff} [A]	I _{eff} [%]	Limit [A]	Result
1	4.353	100.000		
2	155.449E-3	3.571	1.08	PASS
3	111.485E-3	2.561	2.30	PASS
4	22.244E-3	0.511	430.00E-3	PASS
5	42.470E-3	0.976	1.14	PASS
6	22.616E-3	0.520	300.00E-3	PASS
7	60.927E-3	1.400	770.00E-3	PASS
8	35.010E-3	0.804	230.00E-3	PASS
9	69.929E-3	1.607	400.00E-3	PASS
10	36.488E-3	0.838	184.00E-3	PASS
11	58.379E-3	1.341	330.00E-3	PASS
12	42.646E-3	0.980	153.33E-3	PASS
13	53.918E-3	1.239	210.00E-3	PASS
14	40.259E-3	0.925	131.43E-3	PASS
15	34.992E-3	0.804	150.00E-3	PASS
16	48.335E-3	1.110	115.00E-3	PASS
17	14.364E-3	0.330	132.35E-3	PASS
18	34.070E-3	0.783	102.22E-3	PASS
19	23.599E-3	0.542	118.42E-3	PASS
20	25.041E-3	0.575	92.00E-3	PASS
21	19.440E-3	0.447	160.71E-3	PASS
22	11.019E-3	0.253	83.64E-3	PASS
23	12.273E-3	0.282	146.74E-3	PASS
24	4.437E-3	0.102	76.66E-3	PASS
25	5.103E-3	0.117	135.00E-3	PASS
26	2.961E-3	0.068	70.77E-3	PASS
27	3.040E-3	0.070	124.99E-3	PASS
28	4.024E-3	0.092	65.71E-3	PASS
29	3.318E-3	0.076	116.39E-3	PASS
30	3.376E-3	0.078	61.33E-3	PASS
31	3.097E-3	0.071	108.87E-3	PASS
32	2.684E-3	0.062	57.50E-3	PASS
33	2.255E-3	0.052	102.27E-3	PASS
34	1.950E-3	0.045	54.12E-3	PASS
35	1.926E-3	0.044	96.44E-3	PASS
36	1.758E-3	0.040	51.11E-3	PASS
37	1.398E-3	0.032	91.21E-3	PASS
38	1.184E-3	0.027	48.42E-3	PASS
39	1.301E-3	0.030	86.53E-3	PASS
40	1.057E-3	0.024	46.00E-3	PASS

Maximum harmonic current results

Hn	I _{eff} [A]	I _{eff} [%]	Limit [A]	Result
1	4.373	100.000		
2	167.984E-3	3.841	1.62	PASS
3	119.585E-3	2.735	3.45	PASS
4	31.340E-3	0.717	645.00E-3	PASS
5	53.492E-3	1.223	1.71	PASS
6	35.229E-3	0.806	450.00E-3	PASS
7	70.344E-3	1.609	1.15	PASS
8	44.558E-3	1.019	345.00E-3	PASS
9	80.640E-3	1.844	600.00E-3	PASS
10	46.845E-3	1.071	276.00E-3	PASS
11	68.144E-3	1.558	495.00E-3	PASS
12	49.121E-3	1.123	229.99E-3	PASS
13	65.696E-3	1.502	315.00E-3	PASS
14	53.112E-3	1.214	197.15E-3	PASS
15	51.975E-3	1.188	225.00E-3	PASS
16	64.248E-3	1.469	172.50E-3	PASS
17	27.114E-3	0.620	198.52E-3	PASS
18	41.650E-3	0.952	153.33E-3	PASS
19	32.373E-3	0.740	177.63E-3	PASS
20	33.742E-3	0.772	138.00E-3	PASS
21	25.872E-3	0.592	160.71E-3	PASS
22	16.035E-3	0.367	125.46E-3	PASS
23	16.056E-3	0.367	146.74E-3	PASS
24	6.745E-3	0.154	114.99E-3	PASS
25	7.670E-3	0.175	135.00E-3	PASS
26	4.154E-3	0.095	106.16E-3	PASS
27	4.479E-3	0.102	124.99E-3	PASS
28	5.372E-3	0.123	98.57E-3	PASS
29	5.097E-3	0.117	116.39E-3	PASS
30	4.723E-3	0.108	92.00E-3	PASS
31	4.308E-3	0.099	108.87E-3	PASS
32	3.762E-3	0.086	86.25E-3	PASS
33	3.050E-3	0.070	102.27E-3	PASS
34	2.639E-3	0.060	81.18E-3	PASS
35	2.882E-3	0.066	96.44E-3	PASS
36	2.444E-3	0.056	76.66E-3	PASS
37	2.219E-3	0.051	91.21E-3	PASS
38	1.688E-3	0.039	72.63E-3	PASS
39	1.776E-3	0.041	86.53E-3	PASS
40	1.545E-3	0.035	69.00E-3	PASS

6. VOLTAGE FLUCTUATION AND FLICKER MEASUREMENT

6.1 Block Diagram of Test Setup

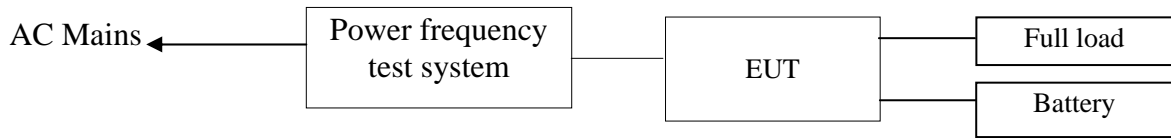

(EUT: UPS)

6.2 Measuring Standard

EN61000-3-3:2008

6.3 Operation Condition of EUT

Same as Section 3.4, except the test setup replaced as Section 6.1.

6.4 Measuring Results

PASS.

Please see the attached pages.

 EN61000-3-3 TEST REPORT

Unit: UPS M/N: GALLEON 2K
 Test mode: ON/OFF
 Manuf: Voltronic
 Operator: King

=====
 TEST SETUP

Test Freq.: 50.00 Hz. Test Voltage: 230.0 vac
 Waveform : SINE
 Test Time: 10.0 min. Tshort: 10.0 min.
 Prog. Zo Enabled: YES Prog. Zo: 0.000
 Voltage Change less than once per Hour: NO
 Impedance selected: IEC-725 STD. REF.
 Synthetic R+L Enabled: NO
 Resistance: 0.380 Ohms Inductance: 460.000 uH

TEST DATA

Result:	PASS			
	EUT Data	Limit	Result	Test Enabled
Pst max	0.128	1.00	PASS	true
Plt max	0.128	0.65	PASS	false
dc %	0.332	3.00	PASS	true
dmax %	0.574	4.00	PASS	true
d(t) sec.	0.000	0.20	PASS	true
	Power Source Data			
Source Pst max	0.022	0.400	PASS	true
% THD	0.03	3.00	PASS	true

END OF REPORT

 EN61000-3-3 TEST REPORT

Unit: UPS M/N: GALLEON 3K
 Test mode: ON/OFF
 Manuf: Voltronic
 Operator: King

=====

TEST SETUP

Test Freq.: 50.00 Hz. Test Voltage: 230.0 vac
 Waveform : SINE
 Test Time: 10.0 min. Tshort: 10.0 min.
 Prog. Zo Enabled: YES Prog. Zo: 0.000
 Voltage Change less than once per Hour: NO
 Impedance selected: IEC-725 STD. REF.
 Synthetic R+L Enabled: NO
 Resistance: 0.380 Ohms Inductance: 460.000 uH

TEST DATA

Result: PASS

	EUT Data	Limit	Result	Test Enabled
Pst max	0.155	1.00	PASS	true
Plt max	0.155	0.65	PASS	false
dc %	0.097	3.00	PASS	true
dmax %	0.732	4.00	PASS	true
d(t) sec.	0.000	0.20	PASS	true
Power Source Data				
Source Pst max	0.022	0.400	PASS	true
% THD	0.03	3.00	PASS	true

END OF REPORT

7. ELECTROSTATIC DISCHARGE IMMUNITY TEST

7.1 Block Diagram of Test Setup

7.1.1 Block diagram of connection between the EUT and simulators



(EUT: UPS)

7.1.2 Block diagram of ESD test setup

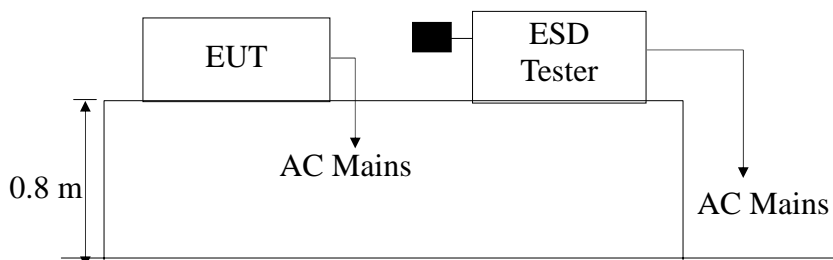

(EUT: UPS)

7.2 Test Standard

EN61000-4-2:2009 (Air Discharge: $\pm 8\text{KV}$, Contact Discharge: $\pm 4\text{KV}$)

7.3 Severity Levels and Performance Criterion

7.3.1 Severity level

Level	Test Voltage Contact Discharge (KV)	Test Voltage Air Discharge (KV)
1.	± 2	± 2
2.	± 4	± 4
3.	± 6	± 8
4.	± 8	± 15
X	Special	Special

7.3.2 Performance criterion : A

	Criterion A
External and internal indications and metering (LCD)	No change
Output characteristics (Load)	No change
Control signals to external devices (Signal line)	No change
Mode of operation	No change

7.4 EUT Configuration

The configuration of EUT are listed in Section 3.4.

7.5 Operating Condition of EUT

Same as conducted emission measurement, which is listed in Section 3.5. except the test set up replaced by Section 7.1.

7.6 Test Procedure

7.6.1 Air Discharge:

This test is done on a non-conductive surface. The round discharge tip of the discharge electrode shall be approached as fast as possible to touch the EUT. After each discharge, the discharge electrode shall be removed from the EUT. The generator is then re-triggered for a new single discharge and repeated 10 times for each pre-selected test point. This procedure shall be repeated until all the air discharge completed

7.6.2 Contact Discharge:

All the procedure shall be same as Section 7.6.1. except that the tip of the discharge electrode shall touch the EUT before the discharge switch is operated.

7.6.3 Indirect discharge for horizontal coupling plane

At least 10 single discharges (in the most sensitive polarity) shall be applied at the front edge of each HCP opposite the center point of each unit (if applicable) of the EUT and 0.1m from the front of the EUT. The long axis of the discharge electrode shall be in the plane of the HCP and perpendicular to its front edge during the discharge.

7.6.4 Indirect discharge for vertical coupling plane

At least 10 single discharge (in the most sensitive polarity) shall be applied to the center of one vertical edge of the coupling plane. The coupling plane, of dimensions 0.5m X 0.5m, is placed parallel to, and positioned at a distance of 0.1m from the EUT. Discharges shall be applied to the coupling plane, with this plane in sufficient different positions that the four faces of the EUT are completely illuminated.

7.7 Test Results

PASS

Please refer to the following pages

Electrostatic Discharge Test Result

SHENZHEN EMTEK CO., LTD

Applicant	: VOLTRONIC POWER TECHNOLOGY CORP.	Test Date	: October 18, 2011
EUT	: UPS	Temperature	: 22
M/N	: Galleon 2K, Galleon 3K	Humidity	: 50%
Power Supply	: AC 230V/50Hz	Criterion	: A
Test Mode	: Line mode/Battery mode	Air discharge	: $\pm 8.0KV$
Test Engineer	: King	Contact discharge:	$\pm 4.0KV$
Location		Kind A-Air Discharge C-Contact Discharge	Result
Button	10 points	A	PASS
LED	20 points	A	PASS
Slot of EUT	30 points	A	PASS
Output port	15 points	C	PASS
Screw	20 points	C	PASS
Metal part	30 points	C	PASS
HCP		C	PASS
VCP of front		C	PASS
VCP of rear		C	PASS
VCP of left		C	PASS
VCP of right		C	PASS
Test Equipment: ESD Simulator (EMTEST, ESD 30C)			

8. RF FIELD STRENGTH SUSCEPTIBILITY TEST

8.1 Block Diagram of Test

8.1.1 Block diagram of connection between the EUT and Load

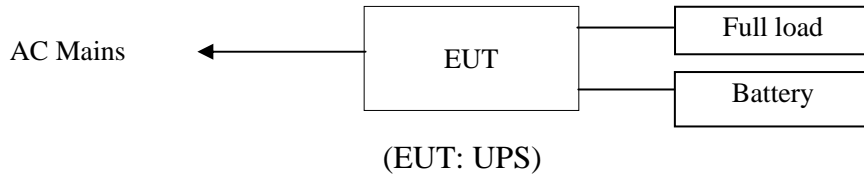

8.1.2 Block diagram of RS test setup

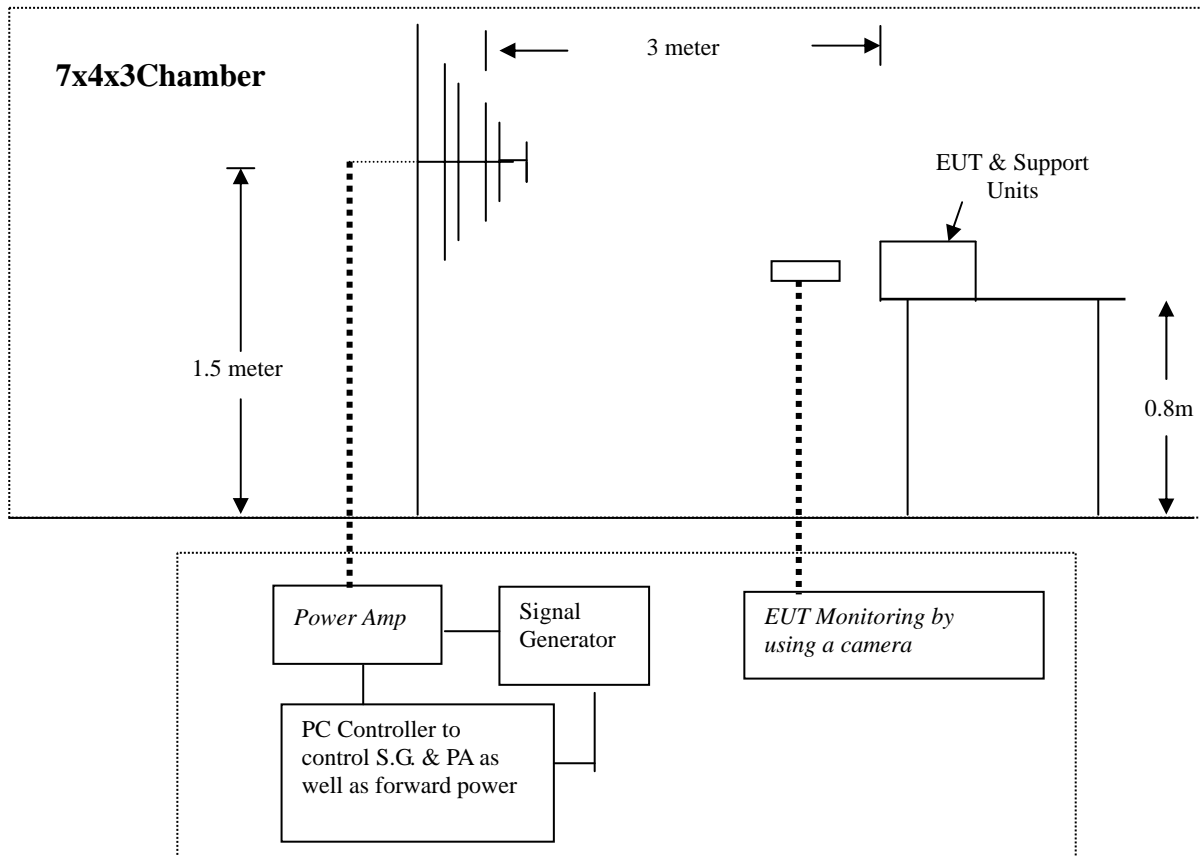

(EUT: UPS)

8.2 Test Standard

EN61000-4-3:2006+A1:2008+A2:2010 (10V / m)

8.3 Severity Levels and Performance Criterion

8.3.1 Severity Levels

Level	Field Strength V/m
1.	1
2.	3
3.	10
X	Special

8.3.2 Performance Criterion : A

	Criterion A
External and internal indications and metering (LCD)	No change
Output characteristics (Load)	No change
Control signals to external devices (Signal line)	No change
Mode of operation	No change

8.4 EUT Configuration on Test

The configuration of the EUT is same as Section 3.4.

8.5 Operating Condition of EUT

Same as radiated emission measurement which is listed in Section 3.5, except the test setup replaced as Section 8.1.

8.6 Test Procedure

The EUT are placed on a table which is 0.8 meter high above the ground. The EUT is set 3 meters away from the transmitting antenna which is mounted on an antenna tower. Both horizontal and vertical polarization of the antenna are set on test. Each of the four sides of the EUT must be faced this transmitting antenna and measured individually.

In order to judge the EUT performance, a CCD camera is used to monitor its screen . All the scanning conditions are as following:

Condition of Test	Remark
-----	-----
1. Fielded Strength	10V/m
2. Radiated Signal	Modulated
3. Scanning Frequency	80-1000MHz
4. Sweep time of radiated	0.0015 Decade/s
5. Dwell Time	1 Sec.

8.7 Test Results

PASS.

Please refer to the following page.

RF Field Strength Susceptibility Test Results

SHENZHEN EMTEK CO., LTD.

Applicant : VOLTRONIC POWER TECHNOLOGY CORP. <hr/> EUT : UPS <hr/> M/N : Galleon 2K, Galleon 3K <hr/> Field Strength : 10V/m <hr/> Power Supply : AC 230V/50Hz <hr/> Test Engineer: King <hr/>	Test Date: October 18, 2011 <hr/> Temperature: 22 <hr/> Humidity : 50 % <hr/> Criterion: A <hr/> Test Mode: Line mode/Battery mode <hr/> Frequency Range: 80 to 1000 MHz <hr/>		
Modulation: <input type="checkbox"/> None <input type="checkbox"/> Pulse <input checked="" type="checkbox"/> AM 1KHz 80%			
	Frequency Rang 1: 80~ 1000MHz	Frequency Rang 2:	
Steps	# / %	# / %	
	Horizontal	Vertical	Horizontal Vertical
Front	PASS	PASS	
Right	PASS	PASS	
Rear	PASS	PASS	
Left	PASS	PASS	
Test Equipment : 1. Signal Generator : 2023B (AEROFLEX) 2. Power Amplifier : AS0102-55(MILMEGA)&AP32MT215(PRANA) 3. Log.-Per.Antenna: VULP9118E(SCHWARZBECK) 4. Broad-Band Horn Antenna: BBHA 9120L3F(SCHWARZBECK) 5. RF Power Meter. Dual Channel: 4232A(BOONTON) 6. Field Strength Meter: HI-6005(HOLADAY)			
Note:			

9. ELECTRICAL FAST TRANSIENT/BURST IMMUNITY TEST

9.1 Block Diagram of Test Setup

9.1.1. Block Diagram of the EUT



(EUT: UPS)

9.1.2. EFT Test Setup

AC Port:

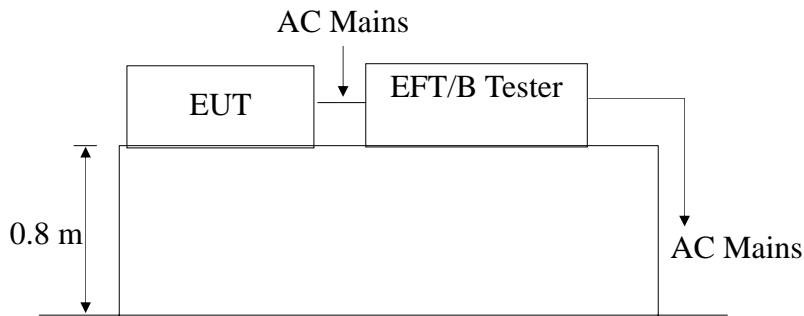

Signal Line:

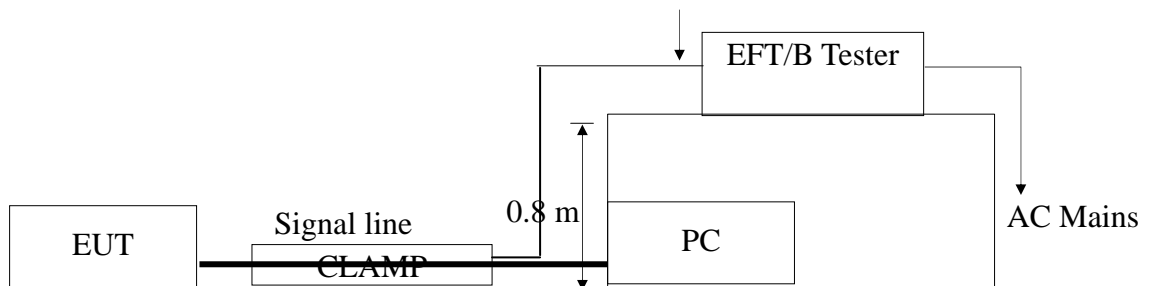

9.2 Test Standard

EN61000-4-4:2004+A1:2010 (Level: 2KV/5kHz)

9.3 Severity Levels and Performance Criterion

9.3.1 Severity level

Open Circuit Output Test Voltage $\pm 10\%$		
Level	On Power Supply Lines	On I/O (Input/Output) Signal data and control lines
1.	0.5 KV	0.25 KV
2.	1 KV	0.5 KV
3.	2 KV	1 KV
4.	4 KV	2 KV
X	Special	Special

9.3.2 Performance criterion : A

	Criterion A
External and internal indications and metering (LCD)	No change
Output characteristics (Load)	No change
Control signals to external devices (Signal line)	No change
Mode of operation	No change

9.4 EUT Configuration

The configuration of EUT are listed in Section 3.4.

9.5 Operating Condition of EUT

- 9.5.1 Setup the EUT as shown in Section 9.1.
- 9.5.2 Turn on the power of all equipments.
- 9.5.3 Let the EUT work in test mode (Line mode) and measure it.

9.6 Test Procedure

The EUT is put on the table which is 0.8 meter high above the ground. This reference ground plane shall project beyond the EUT by at least 0.1m on all sides and the minimum distance between EUT and all other conductive structure, except the ground plane beneath the EUT, shall be more than 0.5m.

9.6.1 For input and output AC power ports:

The EUT is connected to the power mains by using a coupling device which couples the EFT interference signal to AC power lines. Both polarities of the test voltage should be applied during compliance test and the duration of the test is 2 mins.

9.6.2 For signal lines and control lines ports:

The capacitive coupling clamp shall be used for coupling the test voltage into the lines, put the signal lines into the coupling clamp, Grounding of the coaxial cable from the test generator shall be made in the vicinity of the coupling point. Both polarities of the test voltage should be applied during compliance test and the duration of the test is 2 mins.

9.6.3 For DC output line ports:

It's unnecessary to test.

9.7 Test Result

PASS.

Please refer to the following page.

Electrical Fast Transient/Burst Test Results

SHENZHEN EMTEK CO., LTD.

Standard	EN 61000-4-4	Result: <input checked="" type="checkbox"/> PASS / <input type="checkbox"/> FAIL	
Applicant : <u>VOLTRONIC POWER TECHNOLOGY CORP.</u>			
EUT : <u>UPS</u>			
M/N : <u>Galleon 2K, Galleon 3K</u>			
Input Voltage: <u>AC230V/50Hz</u>			
Criterion : A			
Ambient Condition : <u>22</u>		<u>50% RH</u>	
Operation Mode: Line mode			
Line : <input checked="" type="checkbox"/> AC Mains		Line : <input checked="" type="checkbox"/> Signal <input checked="" type="checkbox"/> I/O Cable	
Coupling : <input checked="" type="checkbox"/> Direct		Coupling : <input checked="" type="checkbox"/> Capacitive	
Test Time : 120s			
Line	Test Voltage	Result(+)	Result(-)
L	2KV	PASS	PASS
N	2KV	PASS	PASS
PE	2KV	PASS	PASS
L、 N	2KV	PASS	PASS
L、 PE	2KV	PASS	PASS
N、 PE	2KV	PASS	PASS
L、 N、 PE	2KV	PASS	PASS
<i>Note:</i>			
Test Equipment		Burst Tester Model : PEFT 4010	

10. SURGE IMMUNITY TEST

10.1 Block Diagram of Test Setup

10.1.1 Block Diagram of the EUT



(EUT: UPS)

10.1.2. Surge Test Setup

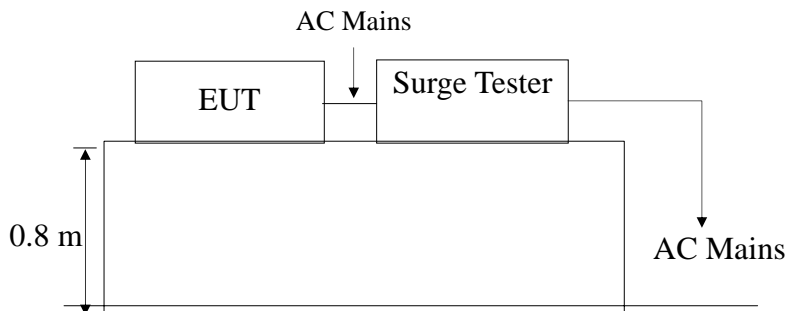

10.2 Test Standard

EN61000-4-5:2006 (Line to Line: Level, 1.0KV, Line to earth: 2.0KV)

10.3 Severity Levels and Performance Criterion

10.3.1. Severity level

Severity Level	Open-Circuit Test Voltage KV
1	0.5
2	1.0
3	2.0
4	4.0
*	Special

10.3.2 Performance criterion : **B**

	Criterion B
External and internal indications and metering (LCD)	No change
Output characteristics (Load)	No change
Control signals to external devices (Signal line)	No change
Mode of operation	No change

10.4 EUT Configuration

The configuration of EUT are listed in Section 3.4.

10.5 Operating Condition of EUT

10.5.1 Setup the EUT as shown in Section 10.1.

10.5.2. Turn on the power of all equipments.

10.5.3. Let the EUT work in test mode (Line mode) and measure it.

10.6 Test Procedure

- 1) Set up the EUT and test generator as shown on Section 10.1.2.
- 2) For line to line coupling mode, provide a 1.2/50us voltage surge (at open-circuit condition) and 8/20us current surge to EUT selected points.
- 3) At least 5 positive and 5 negative (polarity) tests with a maximum 1/min repetition rate are conducted during test.
- 4) Different phase angles are done individually.
- 5) Record the EUT operating situation during compliance test and decide the EUT immunity criterion for above each test.

10.7 Test Result

PASS.

Please refer to the following page.

Surge Immunity Test Result

SHENZHEN EMTEK CO., LTD.

Applicant: VOLTRONIC POWER TECHNOLOGY CORP.				Test Date : <u>October 18, 2011</u>	
EUT : <u>UPS</u>				Temperature : <u>22</u>	
M/N : <u>Galleon 2K, Galleon 3K</u>				Humidity : <u>50%</u>	
Power Supply: <u>AC 230V / 50Hz</u>				Test Mode : <u>Line mode</u>	
Test Engineer: <u>KYLE</u>				Criterion : <u>B</u>	
Location	Polarity	Phase Angle	Number of Pulse	Pulse Voltage (KV)	Result
L-N	+	0°	5	1.0	PASS
	+	90°	5	1.0	PASS
	+	180°	5	1.0	PASS
	+	270°	5	1.0	PASS
	-	0°	5	1.0	PASS
	-	90°	5	1.0	PASS
	-	180°	5	1.0	PASS
	-	270°	5	1.0	PASS
L-PE	+	0°	5	2.0	PASS
	+	90°	5	2.0	PASS
	+	180°	5	2.0	PASS
	+	270°	5	2.0	PASS
	-	0°	5	2.0	PASS
	-	90°	5	2.0	PASS
	-	180°	5	2.0	PASS
	-	270°	5	2.0	PASS
N-PE	+	0°	5	2.0	PASS
	+	90°	5	2.0	PASS
	+	180°	5	2.0	PASS
	+	270°	5	2.0	PASS
	-	0°	5	2.0	PASS
	-	90°	5	2.0	PASS
	-	180°	5	2.0	PASS
	-	270°	5	2.0	PASS
Remark:				Test Equipment : Surge Tester P Surge4.1	

11. INJECTED CURRENTS SUSCEPTIBILITY TEST

11.1 Block Diagram of Test Setup

11.1.1 Block Diagram of the EUT

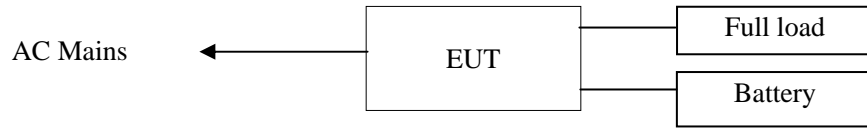

(EUT: UPS)

11.1.2 Block Diagram of Test Setup

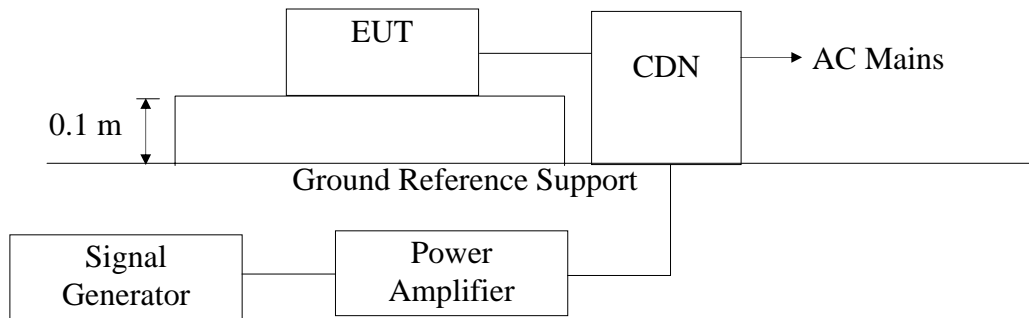

11.2 Test Standard

EN61000-4-6:2009 (Level: 10V (rms), (0.15MHz ~ 80MHz))

11.3 Severity Levels and Performance Criterion

11.3.1 Severity level

Level	Field Strength V
1	1
2	3
3	10
X	Special

11.3.2 Performance criterion: **A**

	Criterion A
External and internal indications and metering (LCD)	No change
Output characteristics (Load)	No change
Control signals to external devices (Signal line)	No change
Mode of operation	No change

11.4 EUT Configuration

The configuration of EUT are listed in Section 3.4.

11.5 Operating Condition of EUT

11.5.1 Setup the EUT as shown in Section 11.1.

11.5.1 Turn on the power of all equipments.

11.5.1 Let the EUT work in test mode (Line mode) and measure it.

11.6 Test Procedure

- 1) Set up the EUT, CDN and test generators as shown on Section 11.1.2.
- 2) Let the EUT work in test mode and measure it.
- 3) The EUT are placed on an insulating support 0.1m high above a ground reference plane. CDN (coupling and decoupling device) is placed on the ground plane about 0.3m from EUT. Cables between CDN and EUT are as short as possible, and their height above the ground reference plane shall be between 30 and 50 mm (where possible).
- 4) The disturbance signal described below is injected to EUT through CDN.
- 5) The EUT operates within its operational mode(s) under intended climatic conditions after power on.
- 6) The frequency range is swept from 150KHz to 80MHz using 3V signal level, and with the disturbance signal 80% amplitude modulated with a 1KHz sine wave.
- 7) The rate of sweep shall not exceed 1.5×10^{-3} decades/s. Where the frequency is swept incrementally, the step size shall not exceed 1% of the start and thereafter 1% of the preceding frequency value.
- 8) Recording the EUT operating situation during compliance testing and decide the EUT immunity criterion.

11.7 Test Results

PASS.

Please refer to the following page.

Injected Currents Susceptibility Test Results

SHENZHEN EMTEK CO., LTD.

Applicant : VOLTRONIC POWER TECHNOLOGY CORP.		Test Date: October 18, 2011		
EUT : <u>UPS</u>		Temperature : <u>22</u>		
M/N : <u>Galleon 2K, Galleon 3K</u>		Humidity : <u>50%</u>		
Power Supply : <u>AC 230V/50Hz</u>				
Test Engineer : <u>King</u>				
Test Mode : <u>Line mode</u>				
Frequency Range (MHz)	Injected Position	Strength (Unmodulated)	Criterion	Result
0.15 ~ 80	AC Mains	10V	A	PASS
Remark : 1. Modulation Signal:1KHz 80% AM Measurement Equipment : Simulator: CWS 500 (SWITZERLAND EMTEST) CDN : <input type="checkbox"/> CDN-M2 (SWITZERLAND EMTEST) <input checked="" type="checkbox"/> CDN-M3 (SWITZERLAND EMTEST)		Note:		

12. MAGNETIC FIELD SUSCEPTIBILITY TEST

12.1 Block Diagram of Test

12.1.1 Block diagram of test setup



(EUT: UPS)

12.1.2 Magnetic field test setup

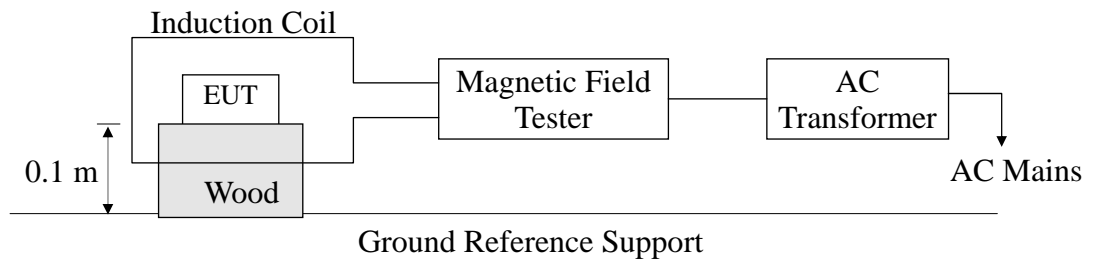

(EUT: UPS)

12.2 Test Standard

EN61000-4-8:2010, Severity Level: 30A / m

12.3 Severity Levels and Performance Criterion

12.3.1 Severity Levels

Level	Field Strength A/m
1	1
2	3
3	10
4	30
5	100
X	Special

12.3.2 Performance Criterion: **B**

	Criterion B
External and internal indications and metering (LCD)	No change
Output characteristics (Load)	No change
Control signals to external devices (Signal line)	No change
Mode of operation	No change

12.4 EUT Configuration on Test

The configuration of the EUT is same as Section 3.3.

12.5 Test Procedure

The EUT is placed in the middle of a induction coil (1*1m), under which is a 1*1*0.1m (high) table, this small table is also placed on a larger table, 0.8 m above the ground. Both horizontal and vertical polarization of the induction coil is set on test, so that each side of the EUT is affected by the magnetic field. Also can reach the same aim by change the position of the EUT.

12.6 Test Results

PASS.

Please refer to the following page.

Magnetic Field Immunity Test Result

SHENZHEN EMTEK CO., LTD.

Standard	EN 61000-4-8		Result: <input checked="" type="checkbox"/> Pass / <input type="checkbox"/> Fail	
Applicant : <u>VOLTRONIC POWER TECHNOLOGY CORP.</u> EUT : <u>UPS</u> M/N: <u>Galleon 2K, Galleon 3K</u> Input Voltage : <u>230V</u> / <u>50Hz</u> Date of Test : <u>October 18, 2011</u> Test Engineer: <u>King</u> Ambient Condition : Temp : <u>22</u> Humid: <u>58%</u> Criterion : B				
Operation Mode : <u>Line mode/Battery mode</u>				
Test Level (A/M)	Testing Duration	Coil Orientation	Criterion	Result
30	5 mins	X	A	PASS
30	5 mins	Y	A	PASS
30	5 mins	Z	A	PASS
Operation Mode :				
Test Level (A/M)	Testing Duration	Coil Orientation	Criterion	Result
Test Equipment	Magnetic Field Test : HEAFELY MAG 100.1			
Note:				

13. VOLTAGE DIPS AND INTERRUPTIONS TEST

13.1 Block Diagram of Test Setup

13.1.1 Block Diagram of the EUT



(EUT: UPS)

13.1.2 Dips Test Setup

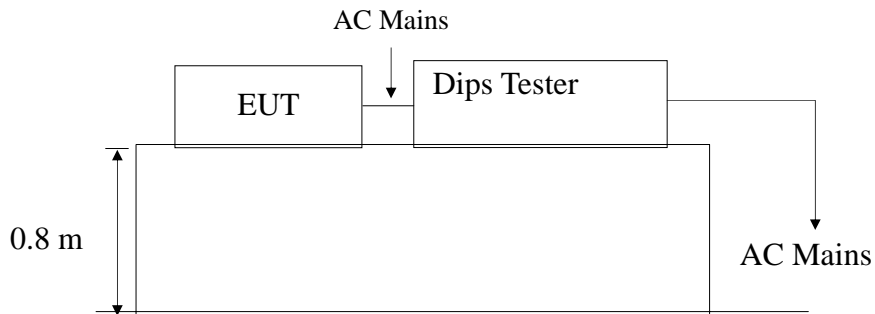

13.2 Test Standard

EN61000-4-11: 2004

13.3 Severity Levels and Performance Criterion

13.3.1 Severity level

Test Level %UT	Voltage dip and short interruptions %UT	Duration (in period)
0	100	0.5
40	60	1
70	30	5
		10
		25
		50
		*

13.3.2 Performance criterion: **B**

	Criterion B
External and internal indications and metering (LCD)	No change
Output characteristics (Load)	No change
Control signals to external devices (Signal line)	No change
Mode of operation	Change

13.4 EUT Configuration

The configuration of EUT is listed in Section 3.3.

13.5 Operating Condition of EUT

13.5.1 Setup the EUT as shown in Section 13.1.

13.5.2 Turn on the power of all equipments.

13.5.3 Let the EUT work in test mode (Line mode/Battery mode) and measure it.

13.6 Test Procedure

- 1) Set up the EUT and test generator as shown on Section 13.1.2.
- 2) The interruption is introduced at selected phase angles with specified duration.
- 3) Record any degradation of performance.

13.7 Test Result

PASS.

Please refer to the following page.

Voltage Dips And Interruptions Test Results

SHENZHEN EMTEK CO., LTD.

Applicant: <u>VOLTRONIC POWER TECHNOLOGY CORP.</u> EUT : <u>UPS</u> M/N : <u>Galleon 2K, Galleon 3K</u> Power Supply : <u>AC230V / 50Hz</u>			Test Date : <u>October 18, 2011</u> Temperature : <u>22</u> Humidity : <u>50%</u> Test Engineer : <u>King</u>	
Test Mode: <u>Line mode</u>				
Test Level % U _T	Voltage Dips & Short Interruptions % U _T	Duration (in periods)	Criterion <input type="checkbox"/> A <input checked="" type="checkbox"/> B <input type="checkbox"/> C <input type="checkbox"/> D	Result P=PASS F=Fail
0	100	250P	B	P
70	30	25P	B	P
0	100	0.5P	B	P
Note:				

14. LOW FREQUENCY SIGNALS TEST

14.1 Block Diagram of Test Setup

14.1.1 Block Diagram of the EUT

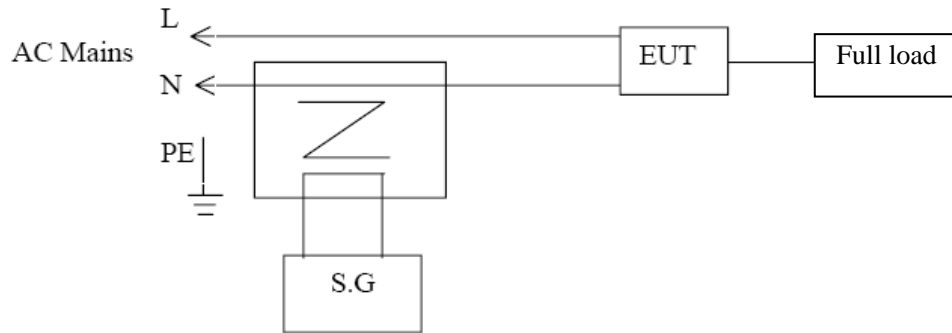

(EUT: UPS)

14.1.2 Block Diagram of Test Setup

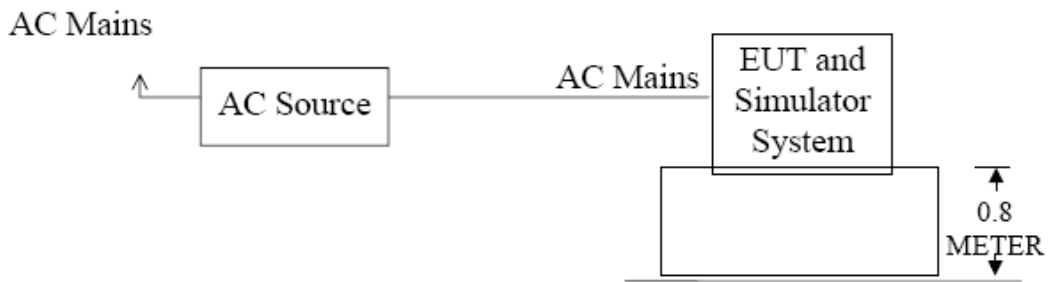

(EUT: UPS)

14.2 Test Standard

EN61000-2-2: 2002, Performance: A

	Criterion A
External and internal indications and metering (LCD)	No change
Output characteristics (Load)	No change
Control signals to external devices (Signal line)	No change
Mode of operation	No change

14.3 Operating Condition of EUT

Same as Section 3.5, Except the test setup replaced by Section 6.1.

14.4 Test Results

PASS.

Please refer to following pages.

Low Frequency Signals Test Result

SHENZHEN EMTEK CO., LTD.

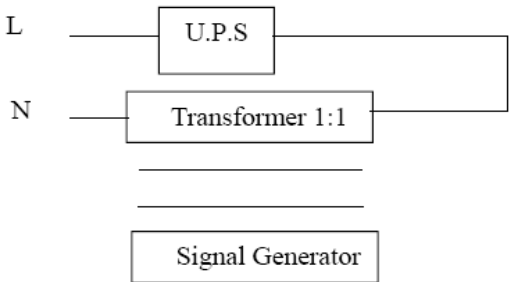
Applicant : <u>VOLTRONIC POWER TECHNOLOGY CORP.</u> EUT : <u>UPS</u> M/N : <u>Galleon 2K, Galleon 3K</u> Power Supply : <u>AC230V/50Hz</u> Test Engineer : <u>King</u>			Test Date: <u>October 18, 2011</u> Temperature : <u>22</u> Humidity : <u>58%</u> Test Mode : <u>Line mode</u>	
Frequency Range (Hz)	Position	Strength	Result	Note
140	See Fig.1	10V(rms) Sinusoidal	PASS	
160			PASS	
200			PASS	
240			PASS	
280			PASS	
320			PASS	
360			PASS	
Note  <p style="text-align: center;">Fig.1</p>			Test Equipment: 1. Isolation transformer Primary: Secondary=1:1 2. Signal Generator AC Source: 65930(Chroma)	

15. TEST PHOTOGRAPH

15.1 Photo of Conducted Emission Measurement



15.2 Photo of Radiation Emission Measurement



15.3 Photos of Harmonic / Flicker Measurement



15.4 Photos of Electrostatic Discharge Test



15.5 Photos of RF Field Strength susceptibility Test

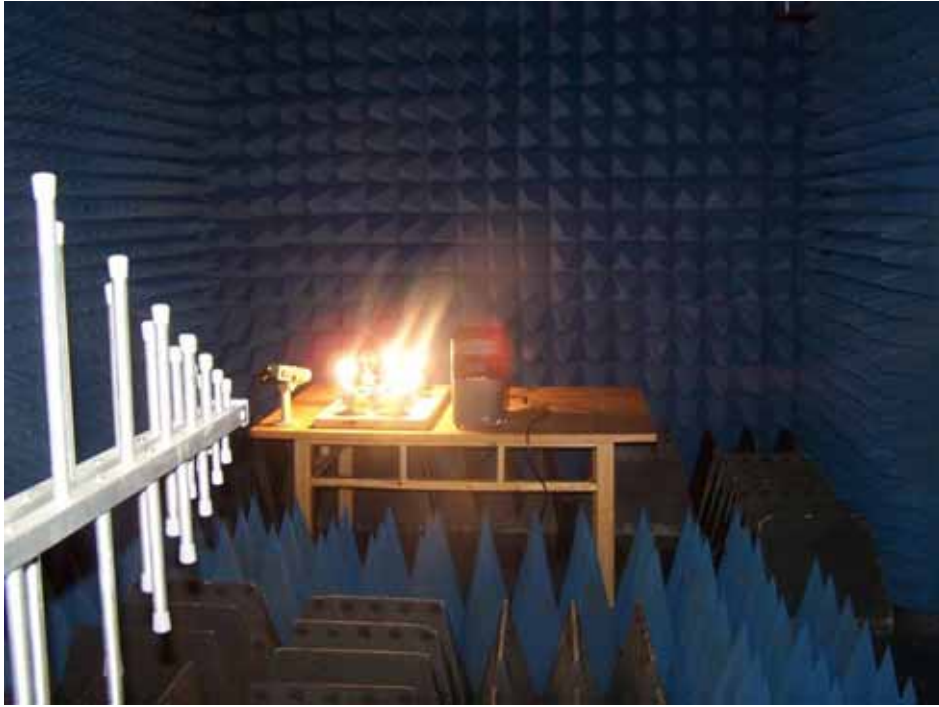

15.6 Photo of Electrical Fast Transient /Burst Test



15.7 Photo of Surge Test



15.8 Photo of Injected Currents Susceptibility Test



15.9 Photo of Magnetic Field Immunity Test



15.10 Photo of Voltage Dips and Interruption Immunity Test



APPENDIX I

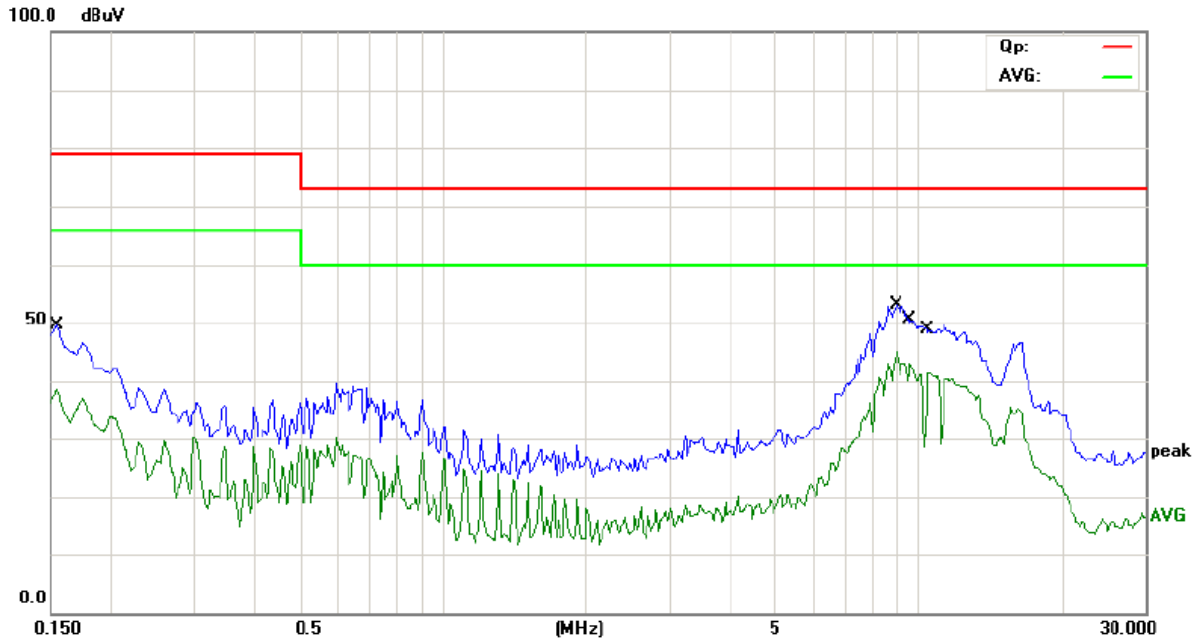

Site site #1 Phase: **L1** Temperature: 22
 Limit: (CE)EN62040-2 C2_QP Power: AC 230V/50Hz Humidity: 50 %
 EUT: UPS
 M/N: Galleon 2k
 Mode: FULL LOAD
 Note: LINE MODE

No.	Mk.	Freq. MHz	Reading Level dBuV	Correct Factor dB	Measure- ment dBuV	Limit dBuV	Over dB	Detector	Comment
1		0.1550	38.64	0.00	38.64	66.00	-27.36	AVG	
2	*	9.0000	45.11	0.00	45.11	60.00	-14.89	AVG	
3		9.6100	43.17	0.00	43.17	60.00	-16.83	AVG	
4		10.4750	41.36	0.00	41.36	60.00	-18.64	AVG	

*:Maximum data x:Over limit !:over margin Comment: Factor build in receiver. Operator: LYX

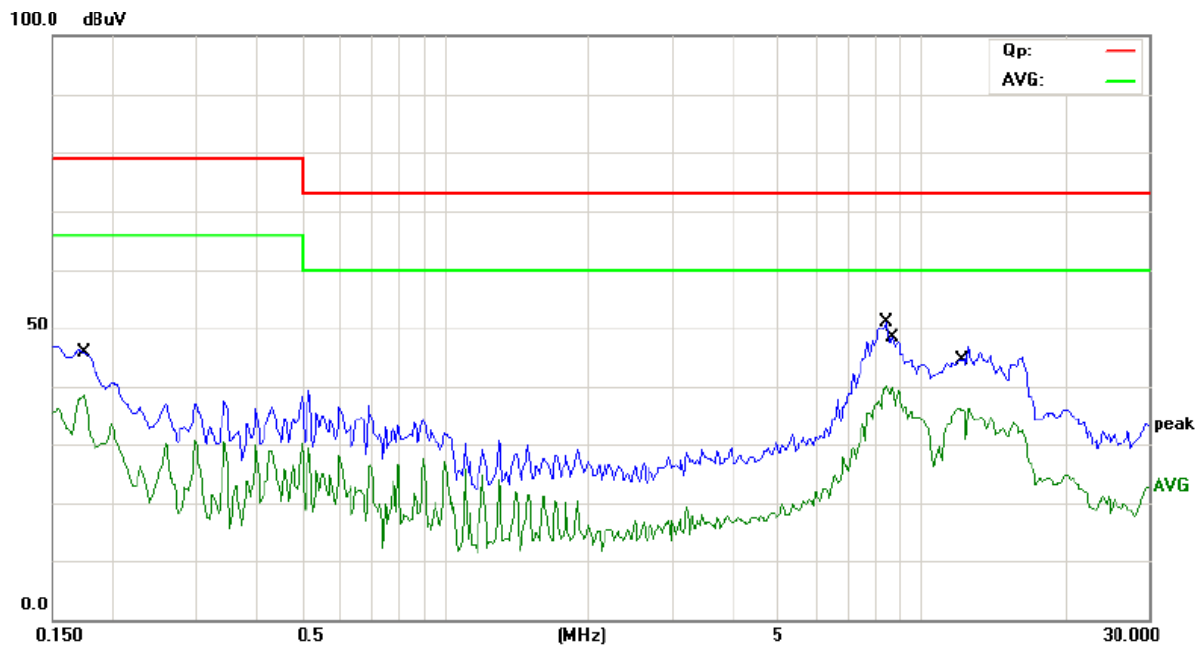

Site site #1 Phase: **N** Temperature: 22
 Limit: (CE)EN62040-2 C2_QP Power: AC 230V/50Hz Humidity: 50 %
 EUT: UPS
 M/N: Galleon 2k
 Mode: FULL LOAD
 Note: LINE MODE

No.	Mk.	Freq. MHz	Reading Level dBuV	Correct Factor dB	Measure- ment dBuV	Limit dBuV	Over dB	Detector	Comment
1		0.1750	38.51	0.00	38.51	66.00	-27.49	AVG	
2	*	8.4200	40.04	0.00	40.04	60.00	-19.96	AVG	
3		8.6900	39.83	0.00	39.83	60.00	-20.17	AVG	
4		12.0000	36.49	0.00	36.49	60.00	-23.51	AVG	

*:Maximum data x:Over limit l:over margin Comment: Factor build in receiver. Operator: LYX

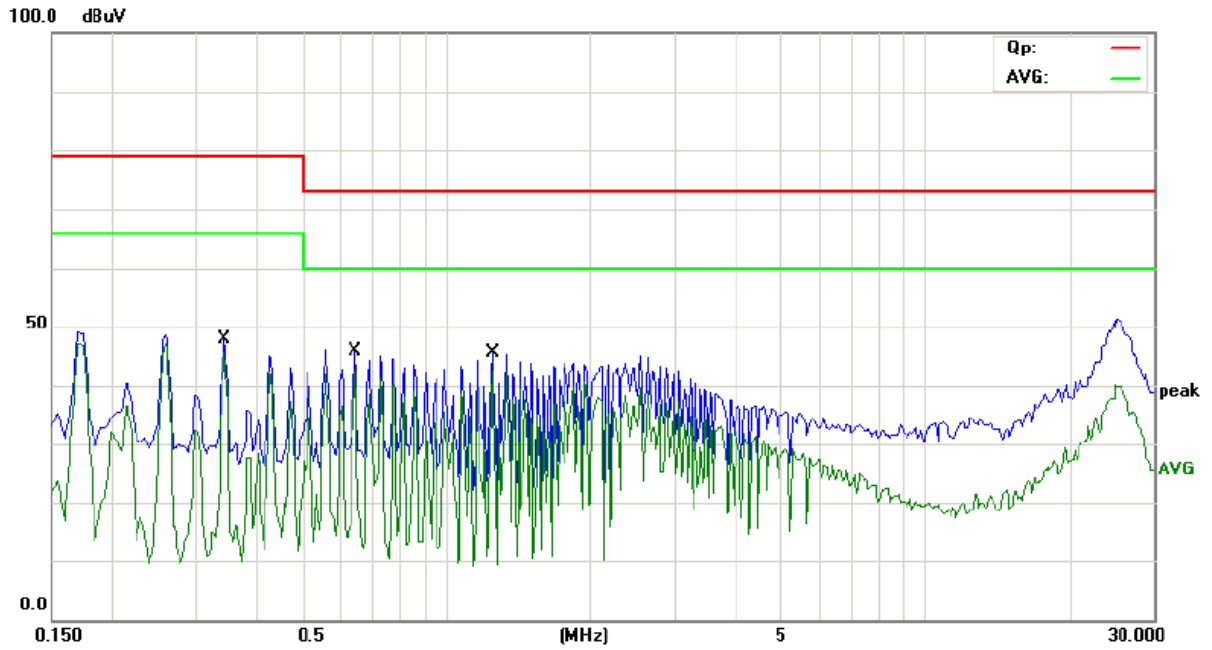

Site site #1 Phase: **L1** Temperature: 22
 Limit: (CE)EN62040-2 C2_QP Power: Humidity: 50 %
 EUT: UPS
 M/N: Galleon 2k
 Mode: FULL LOAD
 Note: BAT MODE

No.	Mk.	Freq. MHz	Reading Level dBuV	Correct Factor dB	Measure- ment dBuV	Limit dBuV	Over dB	Detector	Comment
1		0.3450	45.72	0.00	45.72	66.00	-20.28	AVG	
2	*	0.6450	42.65	0.00	42.65	60.00	-17.35	AVG	
3		1.2500	42.60	0.00	42.60	60.00	-17.40	AVG	

*:Maximum data x:Over limit !:over margin Comment: Factor build in receiver. Operator: LYX

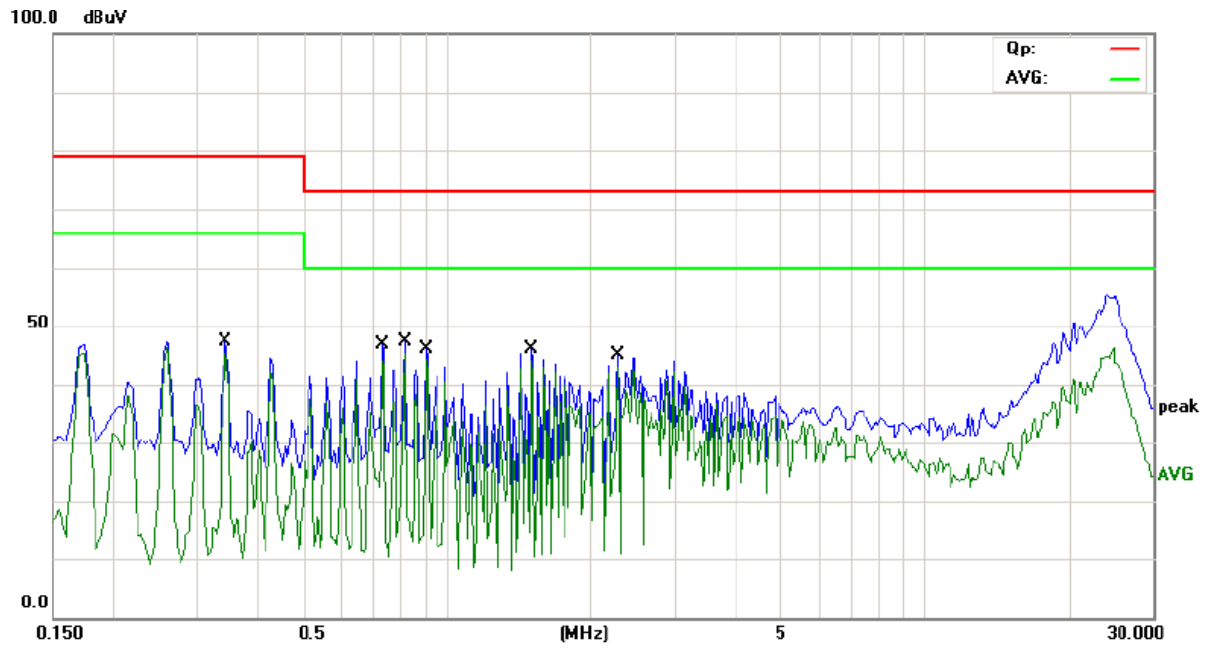

Site site #1 Phase: **N** Temperature: 22
 Limit: (CE)EN62040-2 C2_QP Power: Humidity: 50 %
 EUT: UPS
 M/N: Galleon 2k
 Mode: FULL LOAD
 Note: BAT MODE

No.	Mk.	Freq. MHz	Reading Level dBuV	Correct Factor dB	Measure- ment dBuV	Limit dBuV	Over dB	Detector	Comment
1		0.3450	45.42	0.00	45.42	66.00	-20.58	AVG	
2		0.7350	44.09	0.00	44.09	60.00	-15.91	AVG	
3	*	0.8200	45.31	0.00	45.31	60.00	-14.69	AVG	
4		0.9050	44.33	0.00	44.33	60.00	-15.67	AVG	
5		1.5100	44.21	0.00	44.21	60.00	-15.79	AVG	
6		2.2900	43.12	0.00	43.12	60.00	-16.88	AVG	

*:Maximum data x:Over limit !:over margin Comment: Factor build in receiver. Operator: LYX

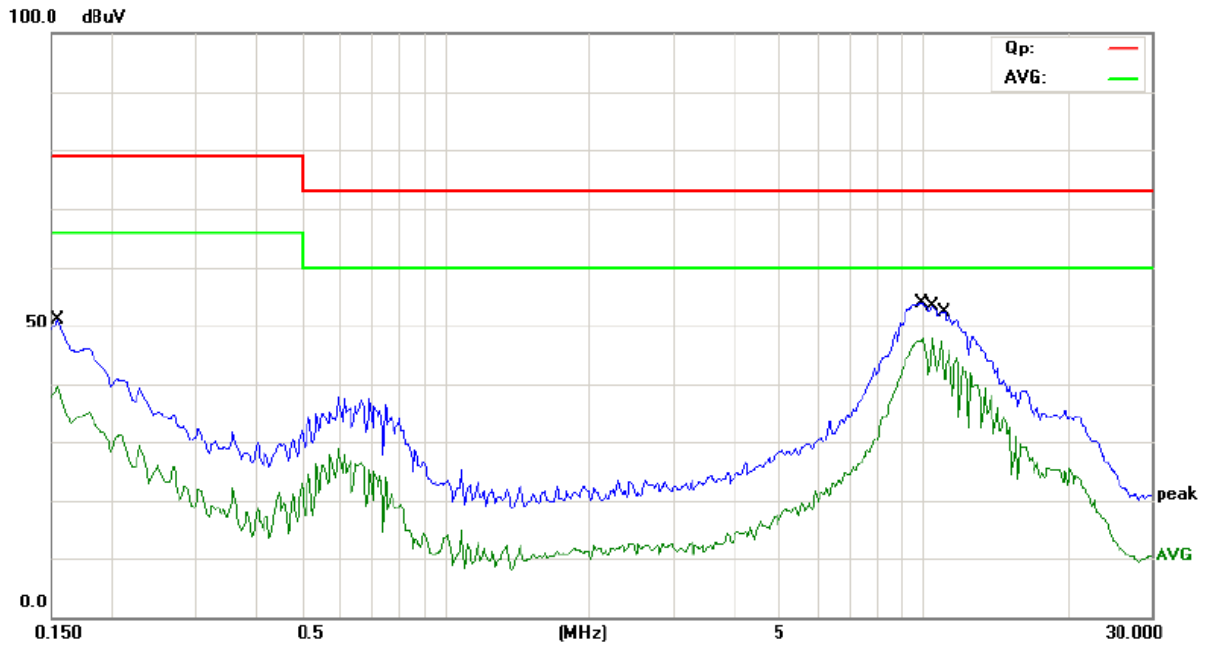

Site site #1 Phase: **L1** Temperature: 22
 Limit: (CE)EN62040-2 C2_QP Power: AC 230V/50Hz Humidity: 50 %
 EUT: UPS
 M/N: Galleon 3k
 Mode: FULL LOAD
 Note: LINE MODE

No.	Mk.	Freq. MHz	Reading Level dBuV	Correct Factor dB	Measure- ment dBuV	Limit dBuV	Over dB	Detector	Comment
1		0.1550	39.52	0.00	39.52	66.00	-26.48	AVG	
2	*	10.0000	47.97	0.00	47.97	60.00	-12.03	AVG	
3		10.4500	47.83	0.00	47.83	60.00	-12.17	AVG	
4		10.9000	47.26	0.00	47.26	60.00	-12.74	AVG	

*:Maximum data x:Over limit !:over margin Comment: Factor build in receiver. Operator: LYX

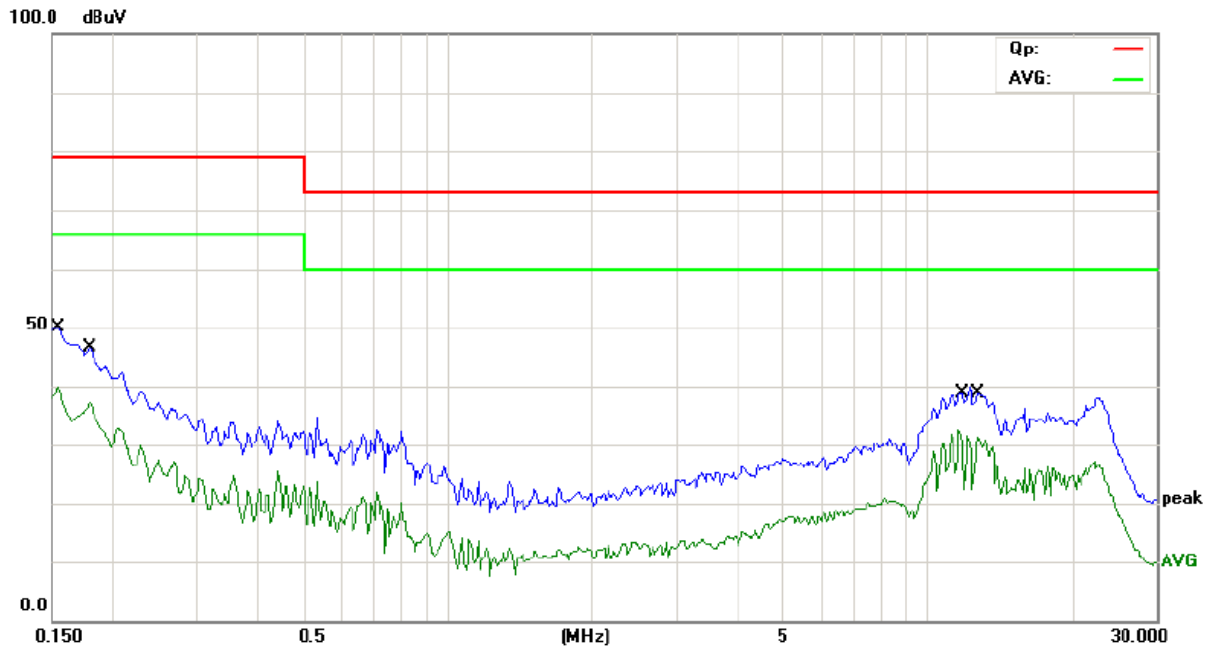

Site site #1 Phase: **N** Temperature: 22
 Limit: (CE)EN62040-2 C2_QP Power: AC 230V/50Hz Humidity: 50 %
 EUT: UPS
 M/N: Galleon 3k
 Mode: FULL LOAD
 Note: LINE MODE

No.	Mk.	Freq. MHz	Reading Level dBuV	Correct Factor dB	Measure- ment dBuV	Limit dBuV	Over dB	Detector	Comment
1	*	0.1550	39.77	0.00	39.77	66.00	-26.23	AVG	
2		0.1800	37.45	0.00	37.45	66.00	-28.55	AVG	
3		11.6750	32.51	0.00	32.51	60.00	-27.49	AVG	
4		12.7500	31.38	0.00	31.38	60.00	-28.62	AVG	

*:Maximum data x:Over limit !:over margin Comment: Factor build in receiver. Operator: LYX

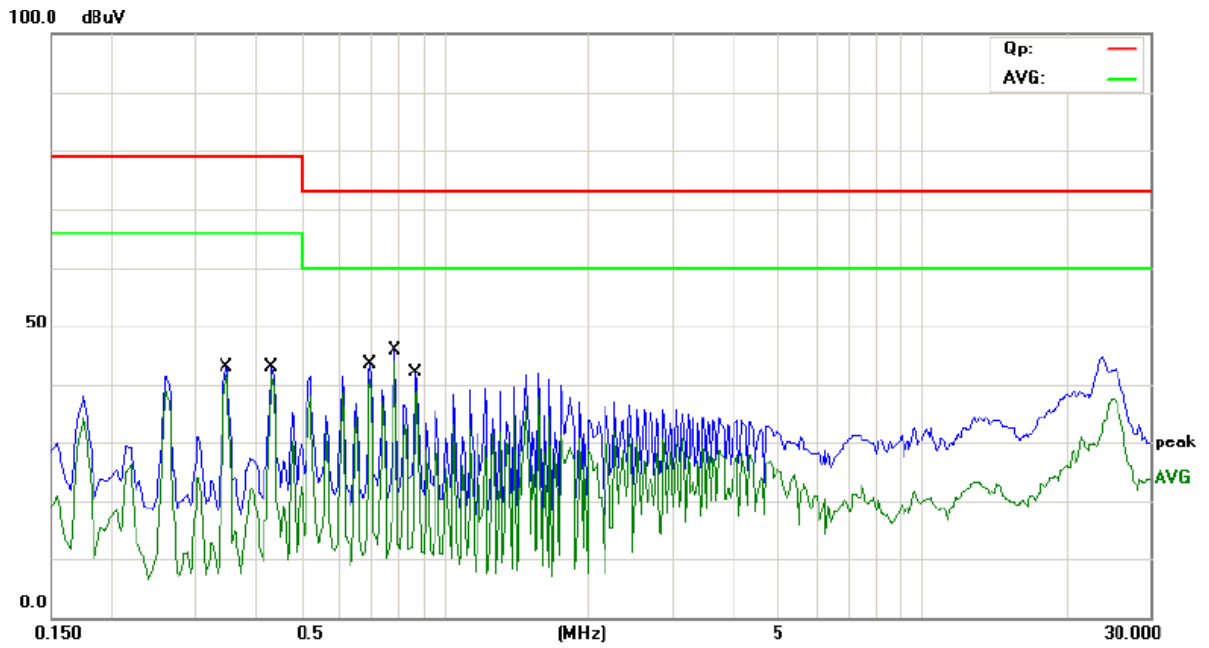

Site site #1 Phase: **L1** Temperature: 22
 Limit: (CE)EN62040-2 C2_QP Power: Humidity: 50 %
 EUT: UPS
 M/N: Galleon 3k
 Mode: FULL LOAD
 Note: BAT MODE

No.	Mk.	Freq. MHz	Reading Level dBuV	Correct Factor dB	Measure- ment dBuV	Limit dBuV	Over dB	Detector	Comment
1		0.3500	41.60	0.00	41.60	66.00	-24.40	AVG	
2		0.4350	41.63	0.00	41.63	66.00	-24.37	AVG	
3		0.7000	40.98	0.00	40.98	60.00	-19.02	AVG	
4	*	0.7850	44.01	0.00	44.01	60.00	-15.99	AVG	
5		0.8750	38.90	0.00	38.90	60.00	-21.10	AVG	

*:Maximum data x:Over limit !:over margin Comment: Factor build in receiver. Operator: LYX

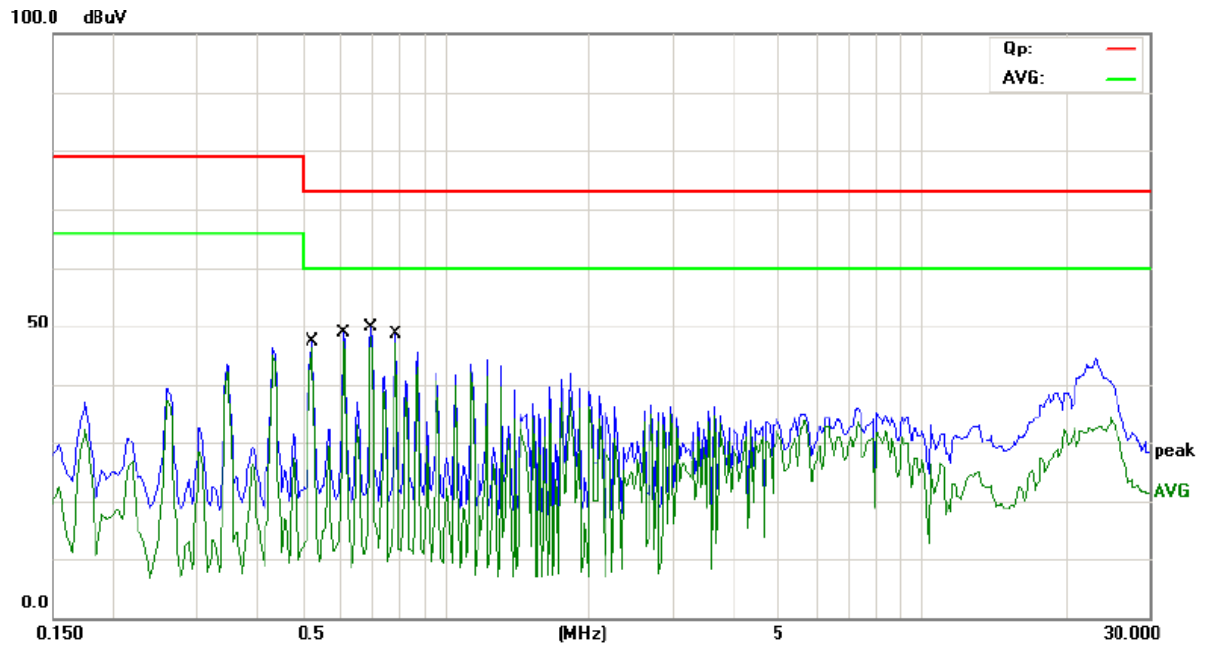

Site site #1 Phase: **N** Temperature: 22
 Limit: (CE)EN62040-2 C2_QP Power: Humidity: 50 %
 EUT: UPS
 M/N: Galleon 3k
 Mode: FULL LOAD
 Note: BAT MODE

No.	Mk.	Freq. MHz	Reading Level dBuV	Correct Factor dB	Measure- ment dBuV	Limit dBuV	Over dB	Detector	Comment
1		0.5250	46.44	0.00	46.44	60.00	-13.56	AVG	
2		0.6100	47.35	0.00	47.35	60.00	-12.65	AVG	
3	*	0.7000	48.10	0.00	48.10	60.00	-11.90	AVG	
4		0.7850	45.70	0.00	45.70	60.00	-14.30	AVG	

*:Maximum data x:Over limit !:over margin Comment: Factor build in receiver. Operator: LYX

APPENDIX II

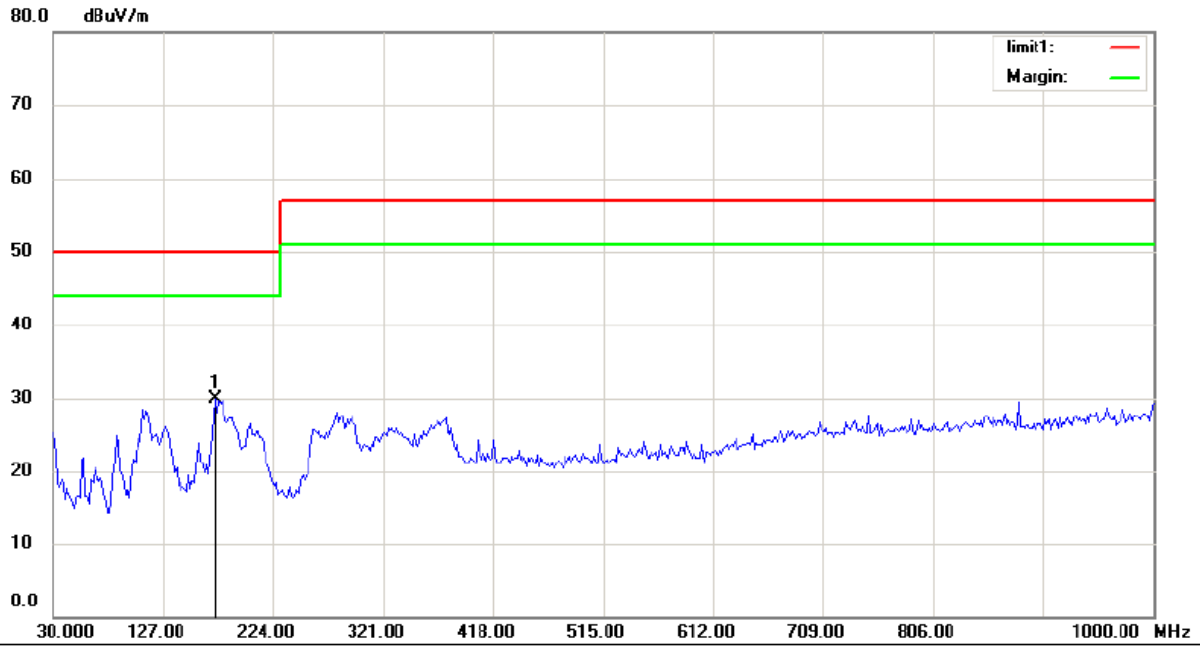

Site site #1 Polarization: **Horizontal** Temperature: 22
 Limit: (RE)EN62040-2 C2 Power: AC 230V/50Hz Humidity: 55 %
 EUT: UPS
 M/N: Galleon 2K
 Mode:FULL LOAD
 Note: LINE MODE

No.	Mk.	Freq.	Reading Level	Correct Factor	Measurement	Limit	Over	Antenna Height	Table Degree	
		MHz	dBuV	dB	dBuV/m	dBuV/m	dB	Detector	cm	degree
1	*	173.0128	19.96	9.93	29.89	50.00	-20.11	QP		Comment

*:Maximum data x:Over limit !:over margin

Operator: ZONE

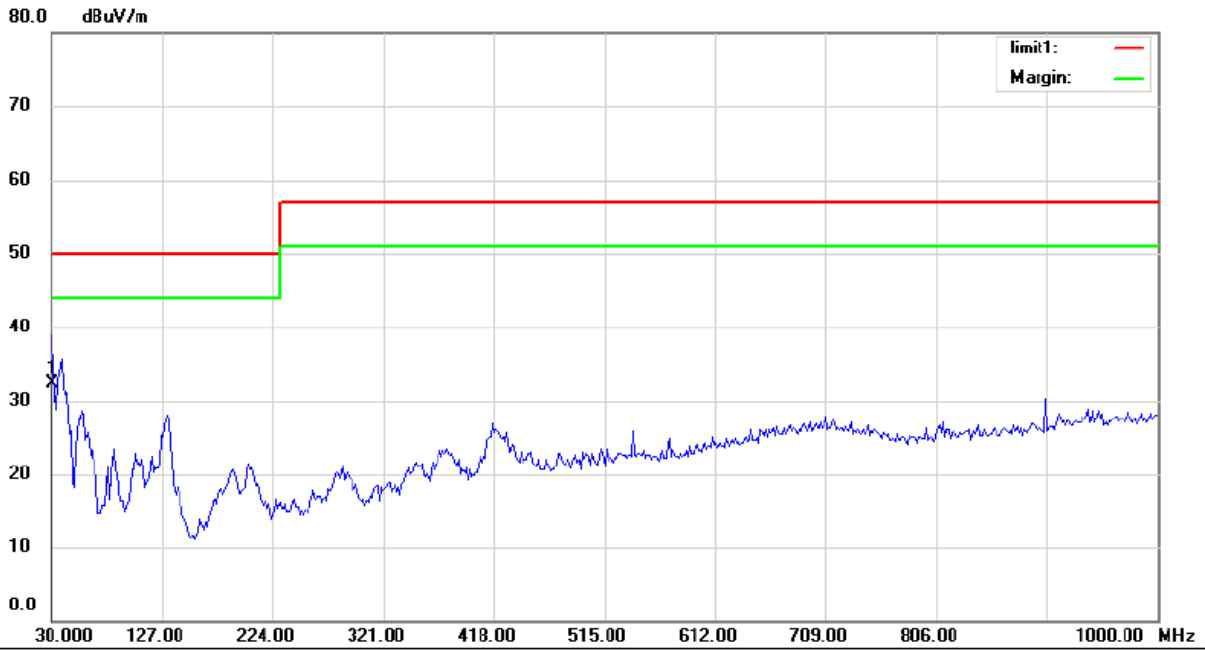

Site site #1 Polarization: **Vertical** Temperature: 22
 Limit: (RE)EN62040-2 C2 Power: AC 230V/50Hz Humidity: 55 %
 EUT: UPS
 M/N: Galleon 2K
 Mode: FULL LOAD
 Note: LINE MODE

No.	Mk.	Freq.	Reading Level	Correct Factor	Measurement	Limit	Over	Antenna Height	Table Degree	
		MHz	dBuV	dB	dBuV/m	dBuV/m	dB	cm	degree	Comment
1	*	30.4006	18.40	13.95	32.35	50.00	-17.65	QP		

*:Maximum data x:Over limit !:over margin

Operator: ZONE

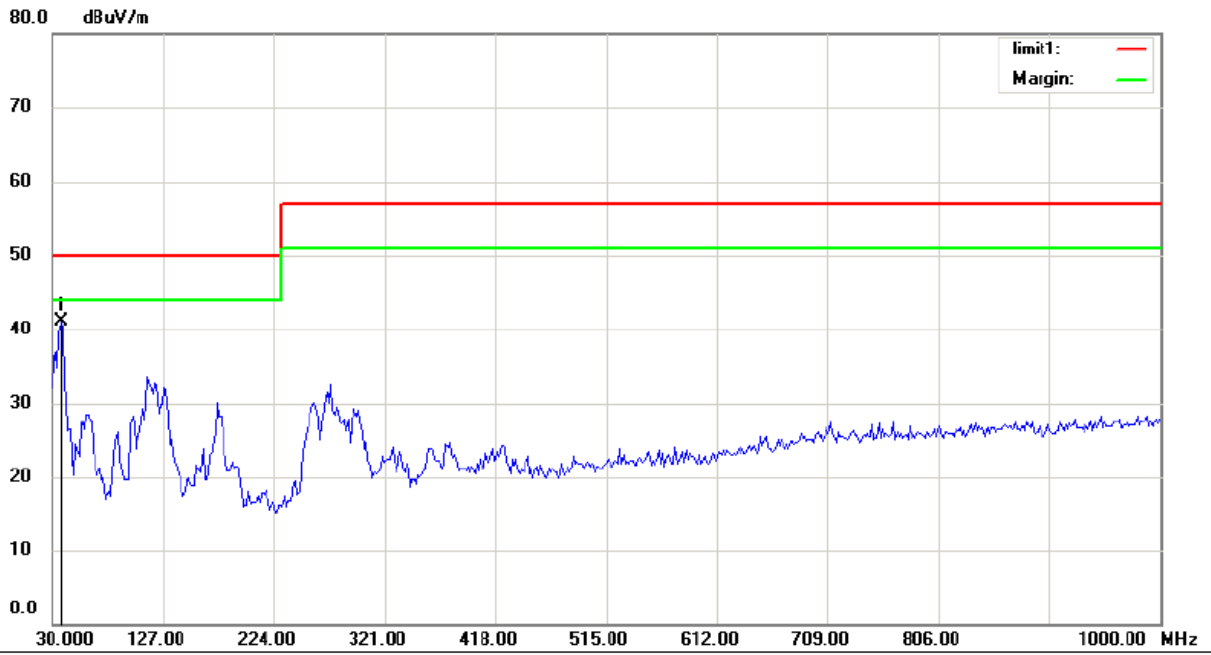

Site site #1 Polarization: **Horizontal** Temperature: 22
 Limit: (RE)EN62040-2 C2 Power: AC 230V/50Hz Humidity: 55 %
 EUT: UPS
 M/N: Galleon 2K
 Mode:FULL LOAD
 Note: BAT MODE

No.	Mk.	Freq.	Reading Level	Correct Factor	Measurement	Limit	Over	Antenna Height	Table Degree	Detector	Comment
		MHz	dBuV	dB	dBuV/m	dBuV/m	dB	cm	degree		
1	*	37.7724	26.88	14.24	41.12	50.00	-8.88			QP	

*:Maximum data x:Over limit !:over margin

Operator: ZONE

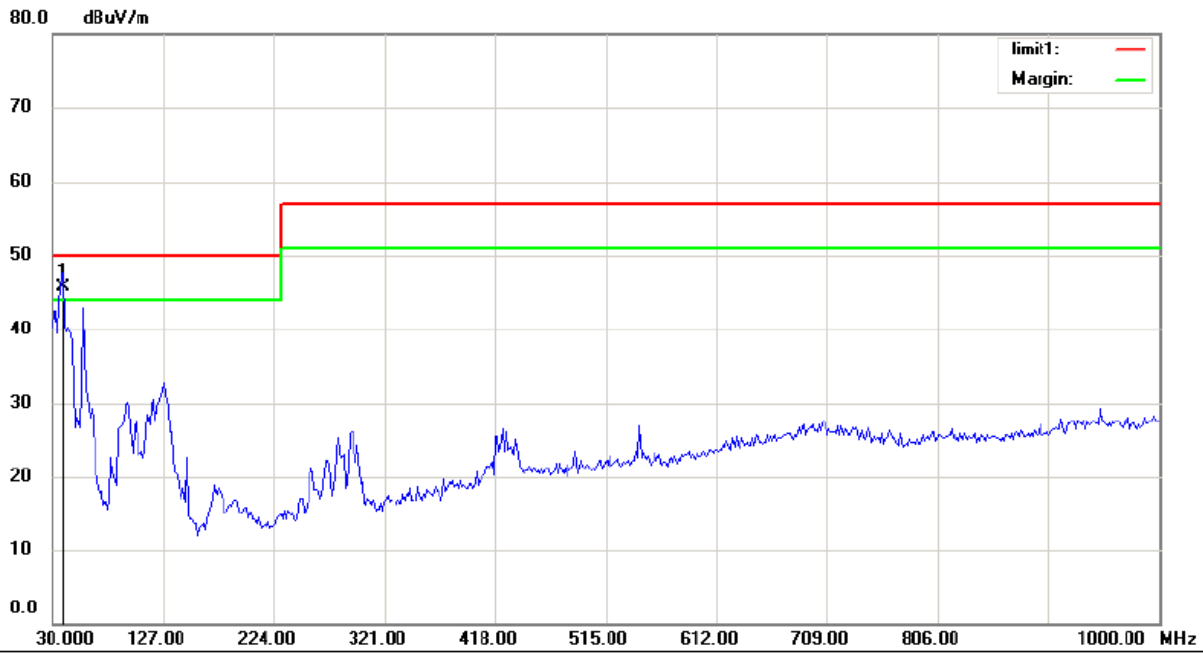

Site site #1 Polarization: **Vertical** Temperature: 22
 Limit: (RE)EN62040-2 C2 Power: AC 230V/50Hz Humidity: 55 %
 EUT: UPS
 M/N: Galleon 2K
 Mode: FULL LOAD
 Note: BAT MODE

No.	Mk.	Freq.	Reading Level	Correct Factor	Measurement	Limit	Over	Antenna Height	Table Degree	
		MHz	dBuV	dB	dBuV/m	dBuV/m	dB	cm	degree	Comment
1	*	39.0540	31.60	14.15	45.75	50.00	-4.25			QP

*:Maximum data x:Over limit !:over margin

Operator: ZONE

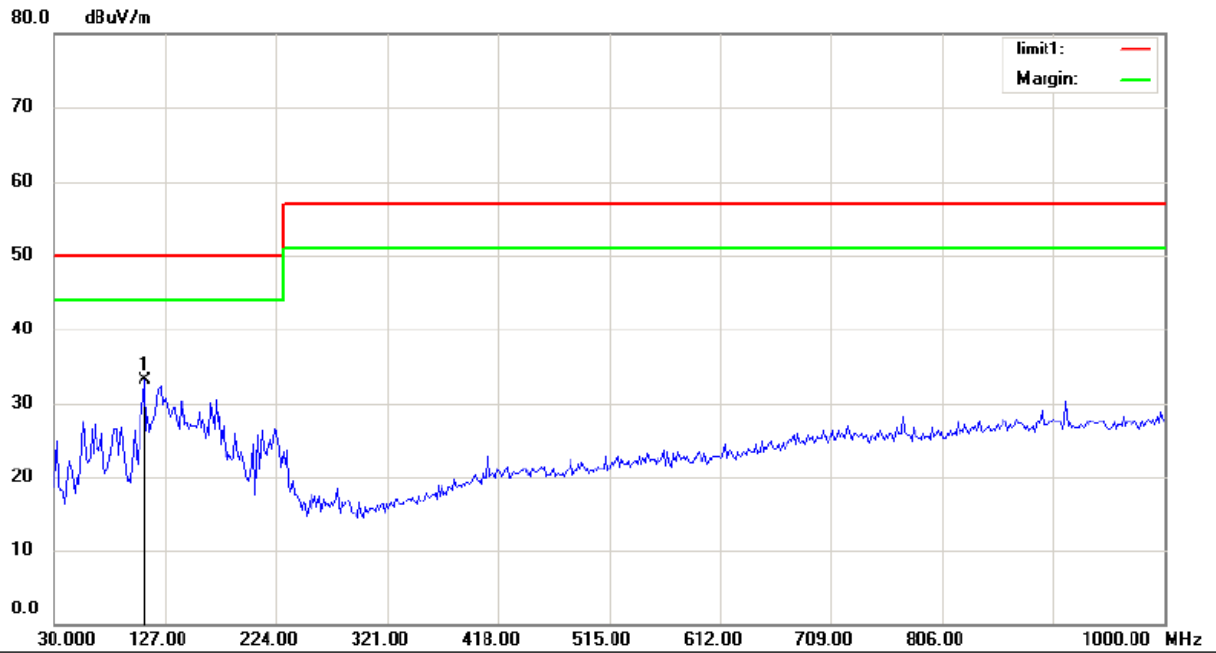

Site site #1 Polarization: **Horizontal** Temperature: 22
 Limit: (RE)EN62040-2 C2 Power: AC 230V/50Hz Humidity: 55 %
 EUT: UPS
 M/N: Galleon 3K
 Mode:FULL LOAD
 Note: LINE MODE

No.	Mk.	Freq.	Reading Level	Correct Factor	Measurement	Limit	Over	Antenna Height	Table Degree	
		MHz	dBuV	dB	dBuV/m	dBuV/m	dB	cm	degree	Comment
1	*	109.2788	20.52	12.51	33.03	50.00	-16.97	QP		

*:Maximum data x:Over limit l:over margin

Operator: ZONE

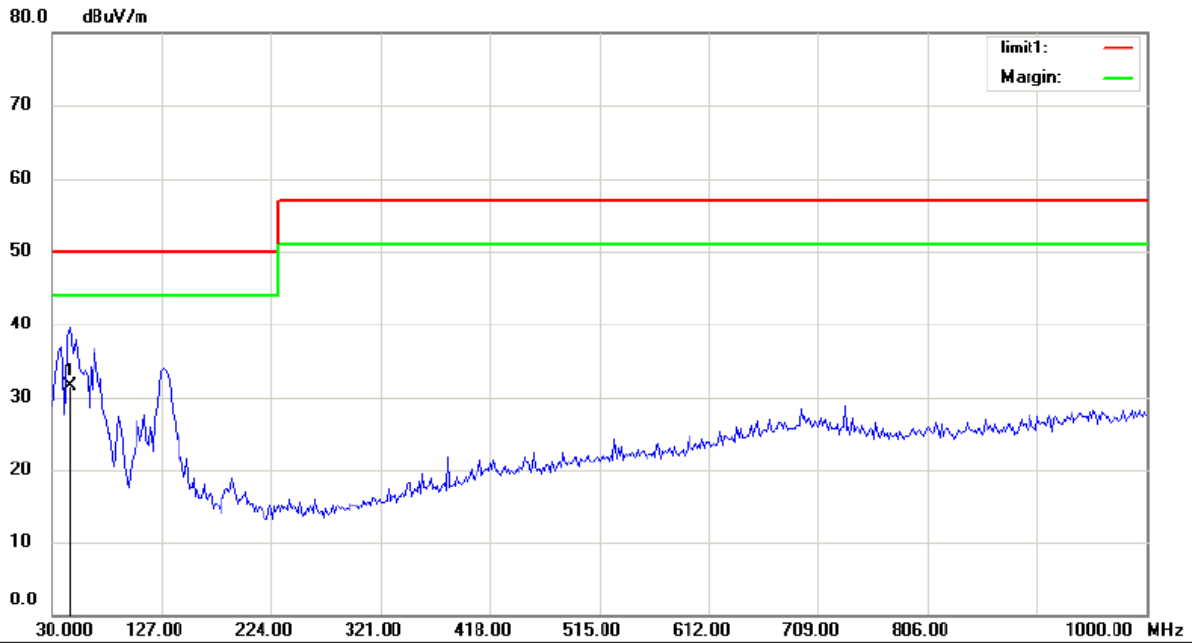

Site site #1 Polarization: **Vertical** Temperature: 22
 Limit: (RE)EN62040-2 C2 Power: AC 230V/50Hz Humidity: 55 %
 EUT: UPS
 M/N: Galleon 3K
 Mode: FULL LOAD
 Note: LINE MODE

No.	Mk.	Freq. MHz	Reading Level dBuV	Correct Factor dB	Measure- ment dBuV/m	Limit dBuV/m	Over dB	Detector	Antenna Height cm	Table Degree	Comment
1	*	45.5448	17.50	14.10	31.60	50.00	-18.40	QP			

*:Maximum data x:Over limit !:over margin

Operator: ZONE

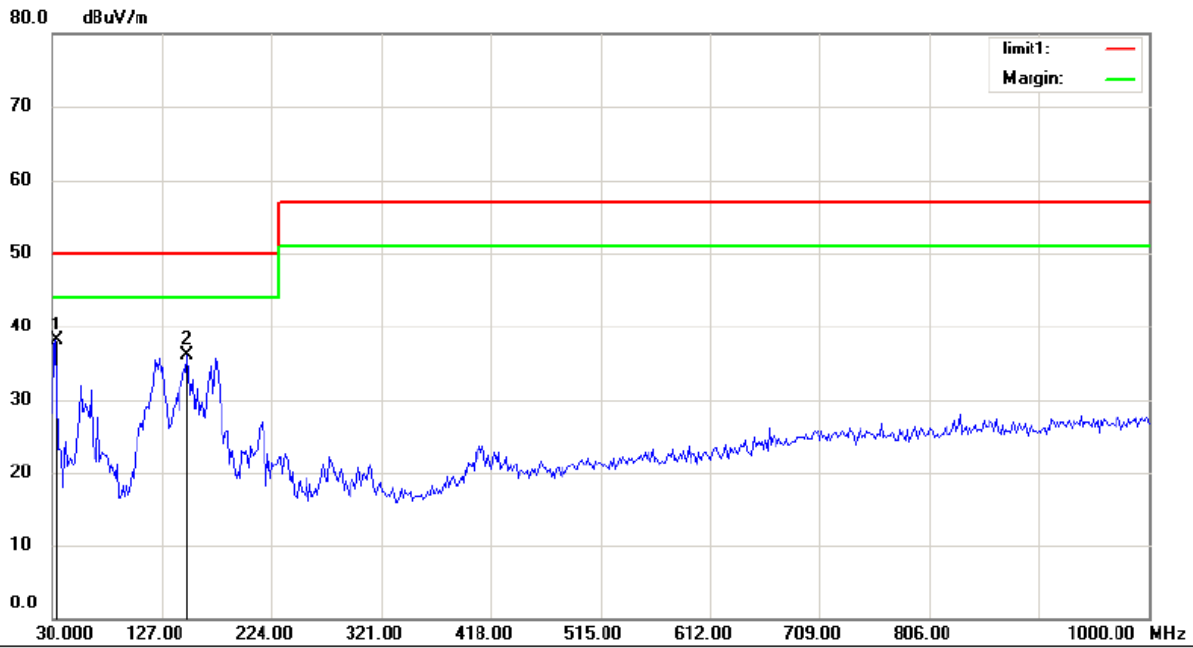

Site site #1 Polarization: **Horizontal** Temperature: 22
 Limit: (RE)EN62040-2 C2 Power: AC 230V/50Hz Humidity: 55 %
 EUT: UPS
 M/N: Galleon 3K
 Mode:FULL LOAD
 Note: BAT MODE

No.	Mk.	Freq.	Reading	Correct	Measure-	Limit	Over	Antenna	Table	
		MHz	Level	Factor	ment			Height	Degree	
			dBuV	dB	dBuV/m	dBuV/m	dB	cm	degree	Comment
1	*	33.1090	24.05	14.13	38.18	50.00	-11.82			QP
2		149.6955	27.02	9.02	36.04	50.00	-13.96			QP

*:Maximum data x:Over limit !:over margin

Operator: ZONE

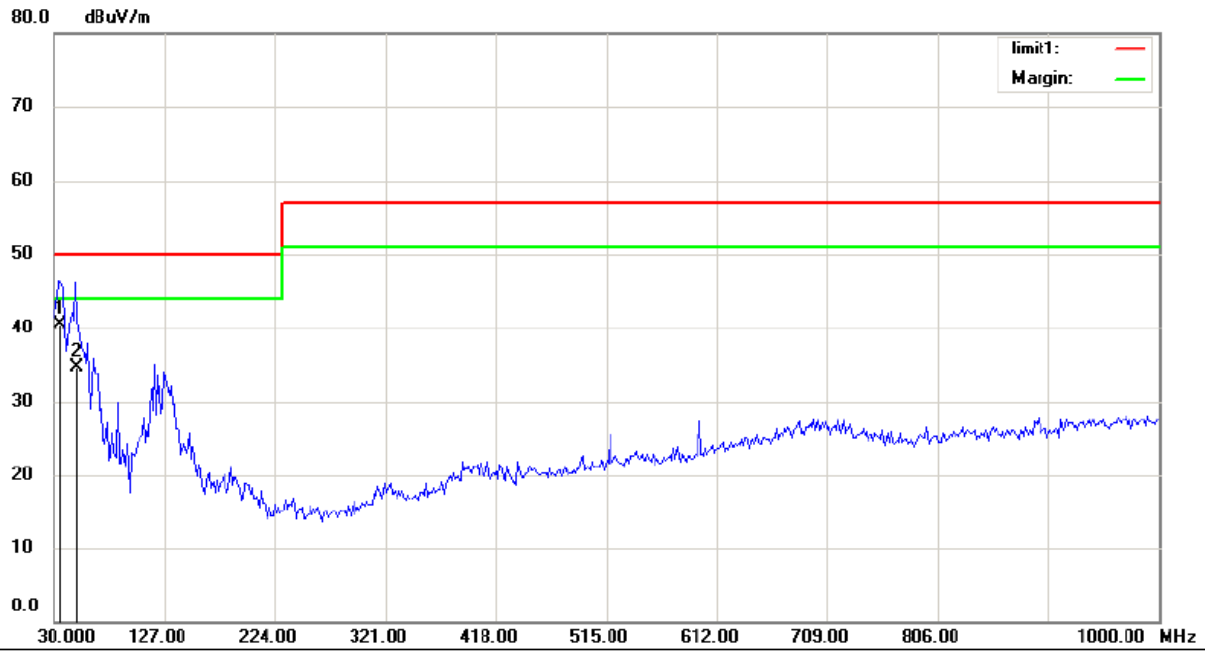

Site site #1 Polarization: **Vertical** Temperature: 22
 Limit: (RE)EN62040-2 C2 Power: AC 230V/50Hz Humidity: 55 %
 EUT: UPS
 M/N: Galleon 3K
 Mode: FULL LOAD
 Note: BAT MODE

No.	Mk.	Freq. MHz	Reading Level dBuV	Correct Factor dB	Measure- ment dBuV/m	Limit dBuV/m	Over dB	Antenna Height cm	Table Degree degree	Comment
1	*	35.9900	26.30	14.22	40.52	50.00	-9.48	QP		
2		49.3360	20.90	13.78	34.68	50.00	-15.32	QP		

*:Maximum data x:Over limit !:over margin

Operator: ZONE

APPENDIX III (PHOTOS OF EUT)

FIGURE 1
GENERAL APPEARANCE OF EUT
Galleon 2K





Galleon 3K:







